

The first name in Italian sofas

the modern collection

03

2014



alberta®

**alberta**<sup>®</sup>  
Made in Italy

**alberta**<sup>®</sup>  
The first name in Italian sofas

Alberta Pacific Furniture S.p.A.  
Via Toniolo, 41  
31028 Vazzola (TV) Italy  
Tel. +39 0438 440440  
Fax +39 0438 441555  
email: [contact@albertasalotti.it](mailto:contact@albertasalotti.it)  
[www.alberta.it](http://www.alberta.it)





## the modern collection

# 03

La **modern collection** accoglie ed esprime le più concrete ed attuali istanze del vivere lo spazio abitativo. Al di là della qualità che è un valore assoluto e dato per scontato, le parole chiave di questa collezione sono: design dalle linee pure, innovativo ed originale, personalizzazione attraverso una vera libertà di scelta ed interpretazione, garanzia di piacevolezza sensoriale e di comfort. Apriamo così il nostro ventaglio di soluzioni. Ed ognuno ci vedrà il proprio mondo.

The modern collection embraces and expresses the most genuine, topical aspirations in modern interior décor. Along with quality, which is an absolute, foregone value, the key features of this collection are: innovative, original designs with clean lines; customisation assured by real freedom of choice and interpretation; guaranteed visual and physical comfort and pleasure. We open our treasure chest of solutions. Everyone will find their own world inside it.

La modern collection accueille et exprime les exigences les plus concrètes et actuelles de la manière de vivre la maison aujourd'hui. Au-delà de la qualité qui est une valeur absolue et qui va de soi, les mots clé de cette collection sont : design aux lignes pures, innovation et originalité, personnalisation à travers une vraie liberté de choix et d'interprétation, garantie de plaisir sensoriel et de confort. Ouvrons donc notre éventail de solutions. Et chacun y verra son propre monde.

Modern collection ist eine Sammlung und ein Ausdruck für die konkreten und überaus aktuellen Ansprüche, die an modernen Wohnkomfort gestellt werden. Abgesehen von Qualität, die einen absoluten Wert darstellt und als selbstverständlich vorausgesetzt wird, sind die wesentlichen Merkmale dieser Kollektion: Design mit klaren, innovativen und originellen Linien, individuelle Gestaltung durch vielfältige Auswahl und Möglichkeiten der Interpretation, angenehme sinnliche Empfindungen und Komfort. So öffnen wir das breite Spektrum unserer Lösungen. Eine eigene Welt für jeden.

alberta®

SIMON	04
HAMILTON	22
ELLE	32
SANTORINI	36
BELLAVITA	72
THEO	78
THEO SLIM	94
MIAMI	100
MIAMI SLIM	105
MIAMI 2	111
ROUTE 66	114
BRIDGE	134
SHAKE	146
UFO	150

disegni tecnici / technical drawings	155
descrizioni tecniche / technical descriptions	177
COMPANY PROFILE	184



# SIMON

Disponibile con rivestimento in tessuto. Sistema modulare caratterizzato da una scocca importante rifinita da un bordo (in contrasto o in tinta) che ne delimita il profilo. Simon è definito da cuscini di seduta e schienale ben distinti che gli donano un carattere borghese. Opzionale la seduta con cuscino unico. Schienale è in piuma d'oca e fibra di poliestere. Seduta in poliuretano espanso, piuma d'oca e fibra di poliestere. La gamma è profonda e comprende elementi con due braccioli e componibili. I divani sono disponibili anche con rete elettrosaldata e materasso in poliuretano espanso.

Fabric covers. A modular system featuring a significant chassis characterized by a trim (contrasting or "ton sur ton") running along the edge. Simon stands out for its clearly defined seat and backrest cushions, which give it an elegant look. Single cushion for the seat provided as optional. Backrest in goose feathers and polyester fiber. Seat in polyurethane foam, goose feathers and polyester fiber. The wide range of the model includes sectional elements and items with two arms both. The sofas can be equipped with electrically-welded spring and polyurethane foam mattress.

Disponible avec revêtement en tissu. Système modulaire caractérisé par une importante coque finie par un passepoil (contrasté ou de la même couleur) qui délimite le profil. Simon est défini par des coussins d'assise et de dossier bien distincts qui lui donnent un charme bourgeois. L'assise avec coussin unique est en option. Le dossier est en duvet d'oie et en fibre de polyester. L'assise est en mousse de polyuréthane, en duvet d'oie et en fibre de polyester. La large gamme comprend des éléments avec deux accoudoirs et modulaires. Les canapés sont également disponibles avec un sommier électrosoudé et un matelas en mousse de polyuréthane.

Verfügbar mit Stoffbezug. Modulares System mit akzentuierter Struktur und Randabschluss (in Kontrastfarbe oder Ton-in-Ton), der das Profil hervorhebt. Die markanten Sitz- und Rückenpolster verleihen diesem Modell einen bürgerlichen Charakter. Das Sitzkissen ist als Option auch in einteiliger Ausführung erhältlich. Rückenpolsterung aus Gänsefedern und Polyesterfaser. Sitzpolsterung aus PU-Schaum, Gänsefedern und Polyesterfasern. Die weite Modellserie schließt Modulare Elemente und Module mit zwei Armlehnen ein. Das Modell SIMON ist auch mit elektro-geschweißter Unterfederung und Matratze aus PU-Schaum erhältlich.

Technical data: p. 156

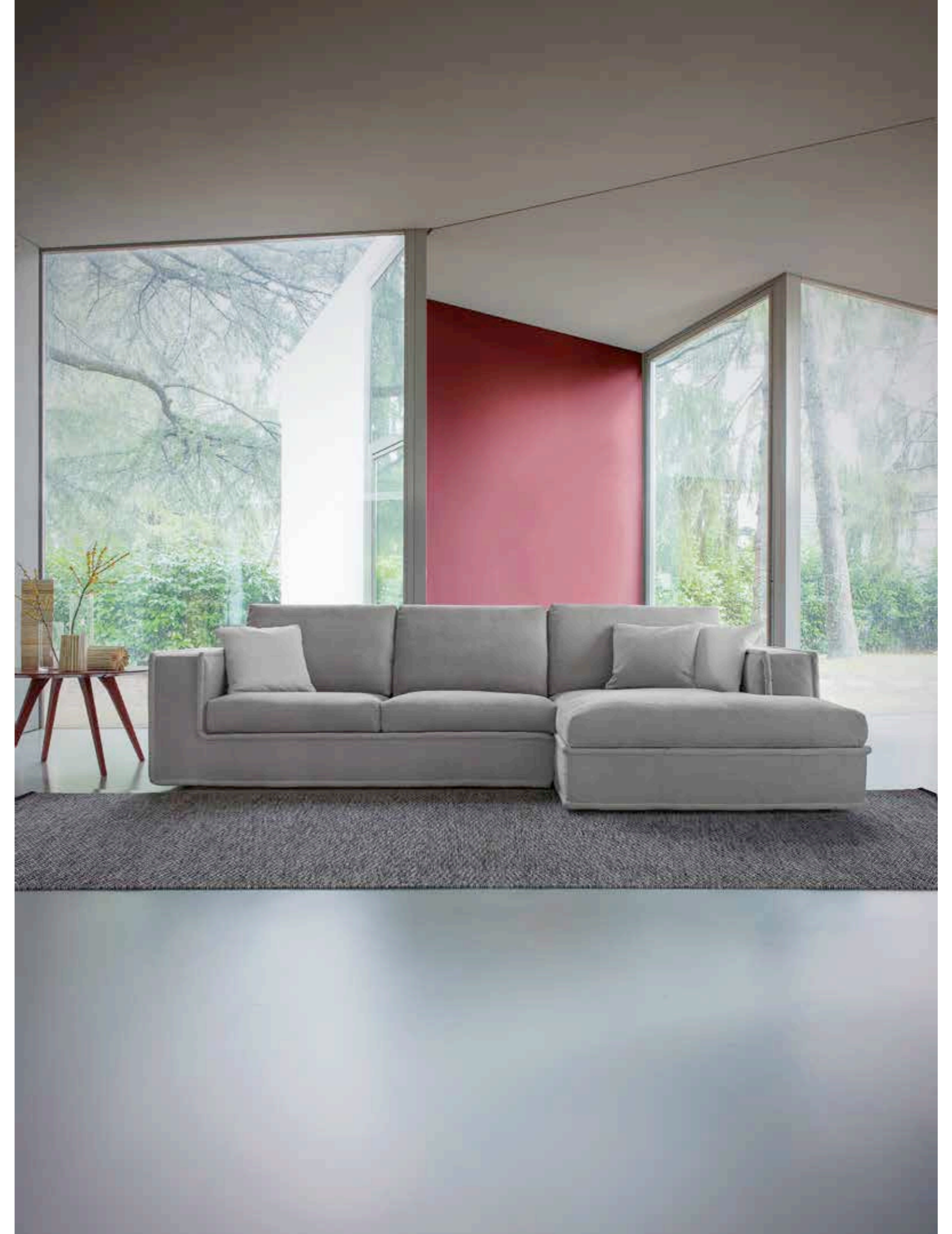



















# HAMILTON

Disponibile con rivestimento in tessuto. Sistema modulare caratterizzato da una scocca importante rifinita da un bordo (in contrasto o in tinta) che ne delimita il profilo. Hamilton ha un cuscino di seduta unico ed è arricchito da numerosi ed accoglienti cuscini sparsi (possono essere di colori diversi) che lo rendono giovane e disinvolto. Schienale è in piuma d'oca e fibra di poliestere. Seduta in poliuretano espanso, piuma d'oca e fibra di poliestere. La gamma è profonda e comprende elementi con due braccioli e componibili. I divani sono disponibili anche con rete elettrosaldata e materasso in poliuretano espanso.

Fabric covers. A modular system featuring a significant chassis characterized by a trim (contrasting or "ton sur ton") running along the edge. Hamilton features a single cushion for the seat and it's characterized by several back cushions (which can be offered in many different colours) giving it a young and relaxed look. Backrest in goose feathers and polyester fiber. Seat in polyurethane foam, goose feathers and polyester fiber. The wide range of the model includes sectional elements and items with two arms. The sofas can be equipped with electrically-welded spring and polyurethane foam mattress.

Disponible avec revêtement en tissu. Système modulaire caractérisé par une importante coque finie par un passepoil (contrasté ou de la même couleur) qui délimite le profil. Hamilton a un coussin d'assise unique et est enrichi par de nombreux petits coussins accueillants et éparpillés (ils peuvent être de différentes couleurs) qui le rendent moderne et désinvolte. Le dossier est en duvet d'oie et en fibre de polyester. L'assise est en mousse de polyuréthane, en duvet d'oie et en fibre de polyester. La large gamme comprend des éléments avec deux accoudoirs et modulaires. Les canapés sont également disponibles avec un sommier électrosoudé et un matelas en mousse de polyuréthane.

Verfügbar mit Stoffbezug. Modulares System mit akzentuierter Struktur und Randabschluss (in Kontrastfarbe oder Ton-in-Ton), der das Profil hervorhebt. HAMILTON besitzt ein einteiliges Sitzpolster, das mit seinen vielen kleinen Kissen zum Sitzen einlädt, die diesem Modell einen jungen, unkonventionellen Stil verleihen (die Kissen sind auch in Kontrastfarben erhältlich). Rückenpolsterung aus Gänsefedern und Polyesterfasern. Sitzpolsterung aus PU-Schaum, Gänsefedern und Polyesterfasern. Die weite Modellserie schliesst modulare Elemente und Elemente mit zwei Armlehnen ein. Das Modell HAMILTON ist auch mit elektrogeschweißter Unterfederung und Matratze aus PU-Schaum erhältlich.

Technical data: p. 157

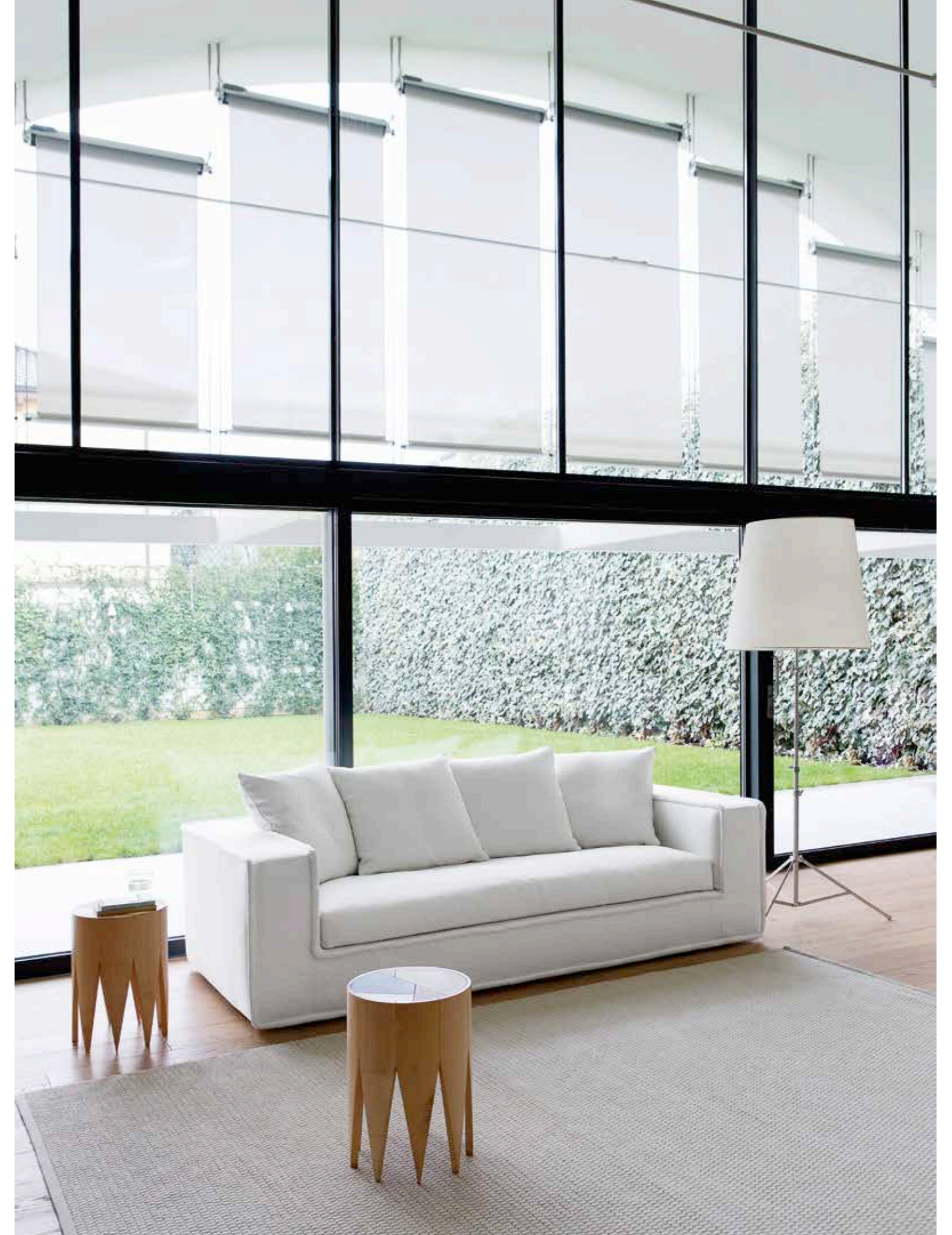











# ELLE

Disponibile con rivestimento in pelle e tessuto non sfoderabile. Si caratterizza per un design essenziale. La seduta, lo schienale e la scocca sono in poliuretano espanso. E' presente una versione fissa ed una con basamento girevole, entrambe con finitura cromata. I braccioli sono in metallo cromato ed hanno copribraccioli in pelle o tessuto a seconda del rivestimento della poltrona.

Leather and fabric (not removable) covers. Essential design. Backrest, seat and chassis are in polyurethane foam. Two options: fix version and swivel base, both with chromium finishing. Chromium-plated metal armrest with covers in leather or fabric (according to the armchair cover).

Disponible avec revêtement en cuir et en tissu non déhoussable. Il se caractérise par un design essentiel. L'assise, le dossier et la coque sont en mousse de polyuréthane. Une version fixe et piètement pivotant, tous les deux avec finition chromée, est également disponible. Les accoudoirs sont en métal chromé et ont des revêtements en cuir ou en tissu assorti avec le revêtement du fauteuil.

Verfügbar mit Leder- und Stoffbezug (nicht abnehmbar). Ein Modell mit nüchternem Design. Sitz- und Rückenpolsterung aus PU-Schaum. Das Modell ELLE umfasst eine unbewegliche Version und eine Version mit drehbarem Unterbau, beide verchromt. Armlehnen aus verchromtem Metall mit Armlehnenbezug aus Leder oder Stoff, je nach dem Sesselbezug.

Technical data: p. 158

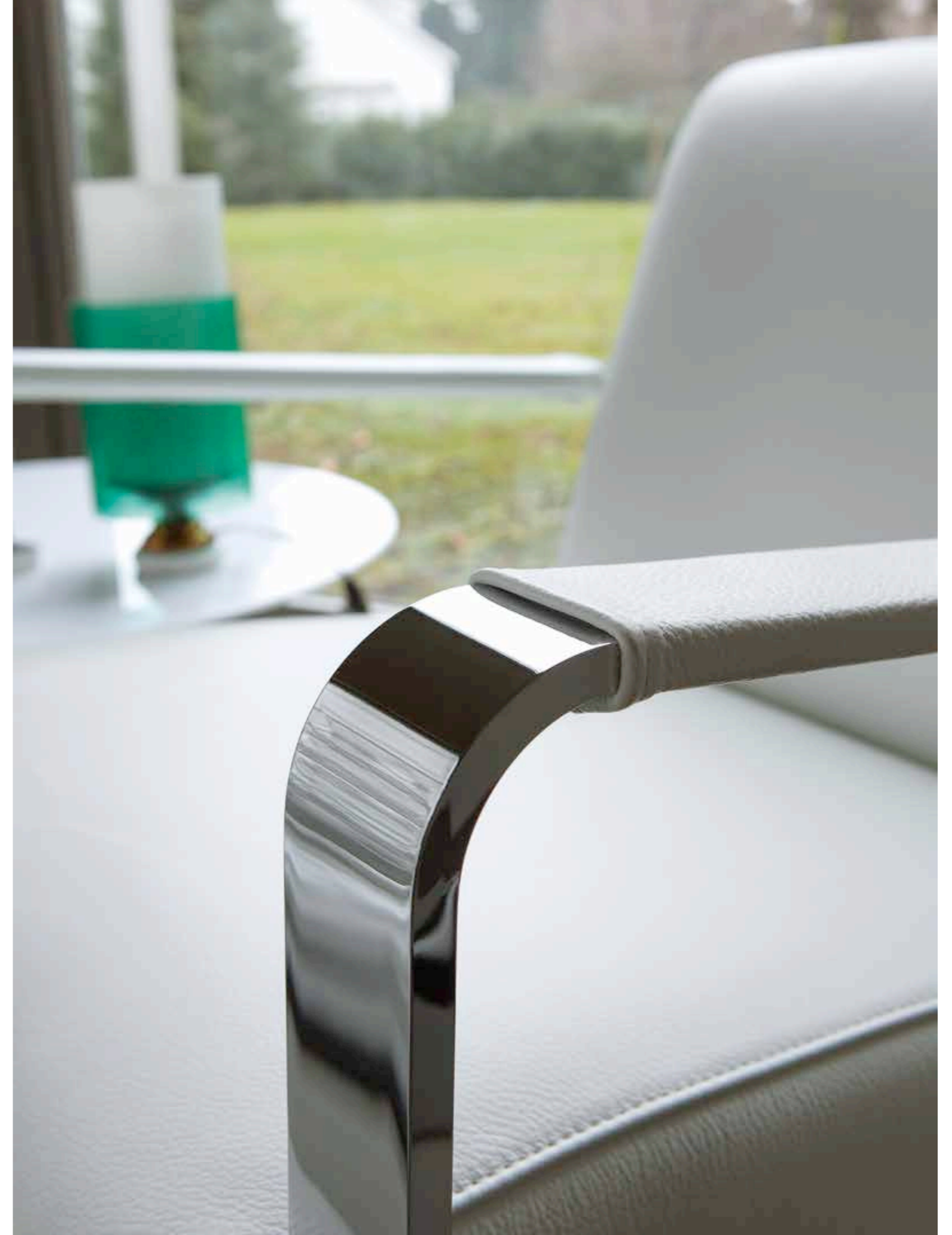



# SANTORINI

Disponibile con rivestimento in tessuto e pelle. Santorini è un modello che reinterpreta in chiave moderna il concetto tradizionale di sofa. Linee essenziali e pulite si coniugano con la ricerca del massimo comfort; elevate sono le possibilità di personalizzazione grazie alla presenza di cuscini schienale di diverse misure. Cuscino di schienale in piuma d'oca, con inserto in poliuretano espanso. Cuscino di seduta in poliuretano espanso, imbottitura in piuma d'oca e fibra di poliestere. Scocca in poliuretano espanso a densità differenziata. La gamma è molto profonda e comprende divani con due braccioli ed elementi componibili. Da segnalare la presenza di elementi a profondità maggiorata. I divani con profondità standard sono disponibili anche con rete elettrosaldata e materasso in poliuretano espanso. Tutto ciò conferisce al modello una grande versatilità, rendendolo adatto ad una progettazione che soddisfa le molteplici necessità del pubblico.

Fabric and leather covers. Model Santorini represents the modern evolution of the traditional sofa concept. Essential shapes are combined with the search for the maximum comfort; customization options thanks to backrest cushions of different sizes. Back cushion in polyurethane foam with upper part in goose feathers. Seat cushion in polyurethane foam with goose feathers and polyester fiber padding. Chassis in polyurethane foam with different densities. The range of elements is very wide and includes sofas with two arms and sectional elements (also deeper elements). The sofas with standard depth can be equipped with electrically-welded spring and polyurethane foam mattress. These features give the model a great versatility, making it suitable to satisfy the different needs of the users.

Disponible avec revêtement en tissu et en cuir. Santorini est un modèle qui réinterprète de manière moderne le concept traditionnel du sofa. Des lignes essentielles et épurées se marient avec la recherche d'un confort maximal; les possibilités de personnalisation sont nombreuses grâce à la présence de coussins de dossier de dimensions différentes. Le rembourrage du dossier est en duvet d'oie avec un insert en mousse de polyuréthane. L'assise est en mousse de polyuréthane avec rembourrage en duvet d'oie et en fibre creuse de polyester. La coque est en mousse de polyuréthane à densité différenciée. La large gamme comprend des canapés avec deux accoudoirs et des éléments modulaires. Il faut signaler la présence d'éléments d'une profondeur plus importante. Les canapés avec une profondeur standard sont également disponibles avec un sommier électrosoudé et un matelas en mousse de polyuréthane. Tout cela rend le modèle polyvalent et adapté à un aménagement devant satisfaire les nombreux besoins du public.

Verfügbar mit Leder- und Stoffbezug. Das Modell Santorini interpretiert das traditionelle Sofa-Konzept in einer modernen Note. Essentielle, reine Linien vereinen sich mit der Suche nach Komfort. Dieses Modell bietet dank Rückenkissen in verschiedenen Größen zahlreiche Personalisierungsmöglichkeiten. Rückenpolsterung aus Gänsefedern mit Einsatz aus PU-Schaum. Sitzfläche aus PU-Schaum mit Polsterung aus Gänsefedern und Polyesterhohlfaser. Struktur aus PU-Schaum mit unterschiedlicher Dichte. Die weite Modellserie schließt modulare Elemente und Elemente mit zwei Armlehnen ein. Als besonderes Merkmal werden einige Elemente mit einer tieferen Sitzausführung angeboten. Die Sofas mit Standard-Sitztiefe sind auch mit elektro-geschweißtem Lattenrost und Matratze aus PU-Schaum erhältlich. Dieses äußerst vielseitige Modell passt sich jedem Gestaltungsbedürfnis an.

Technical data: p. 160 - 163

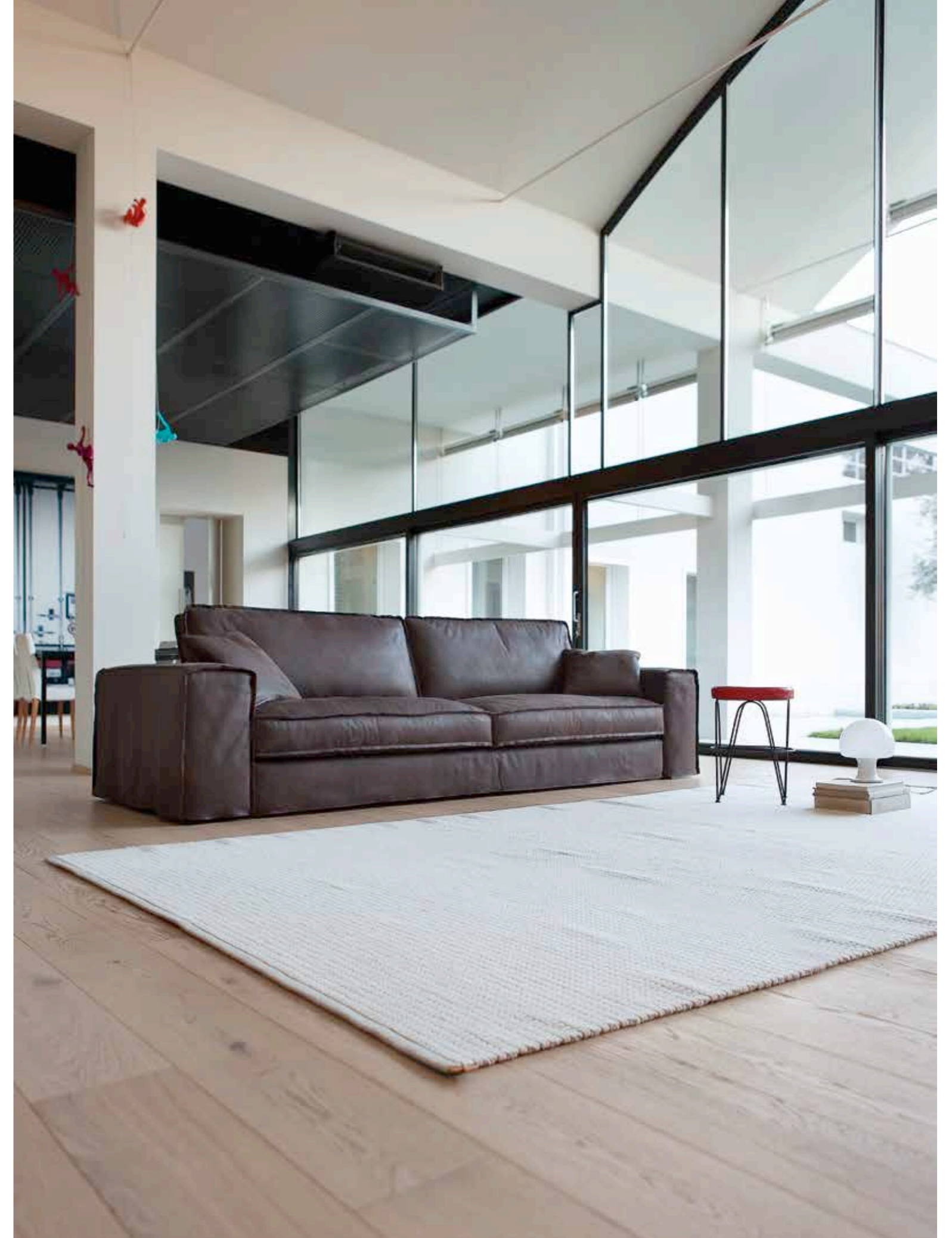



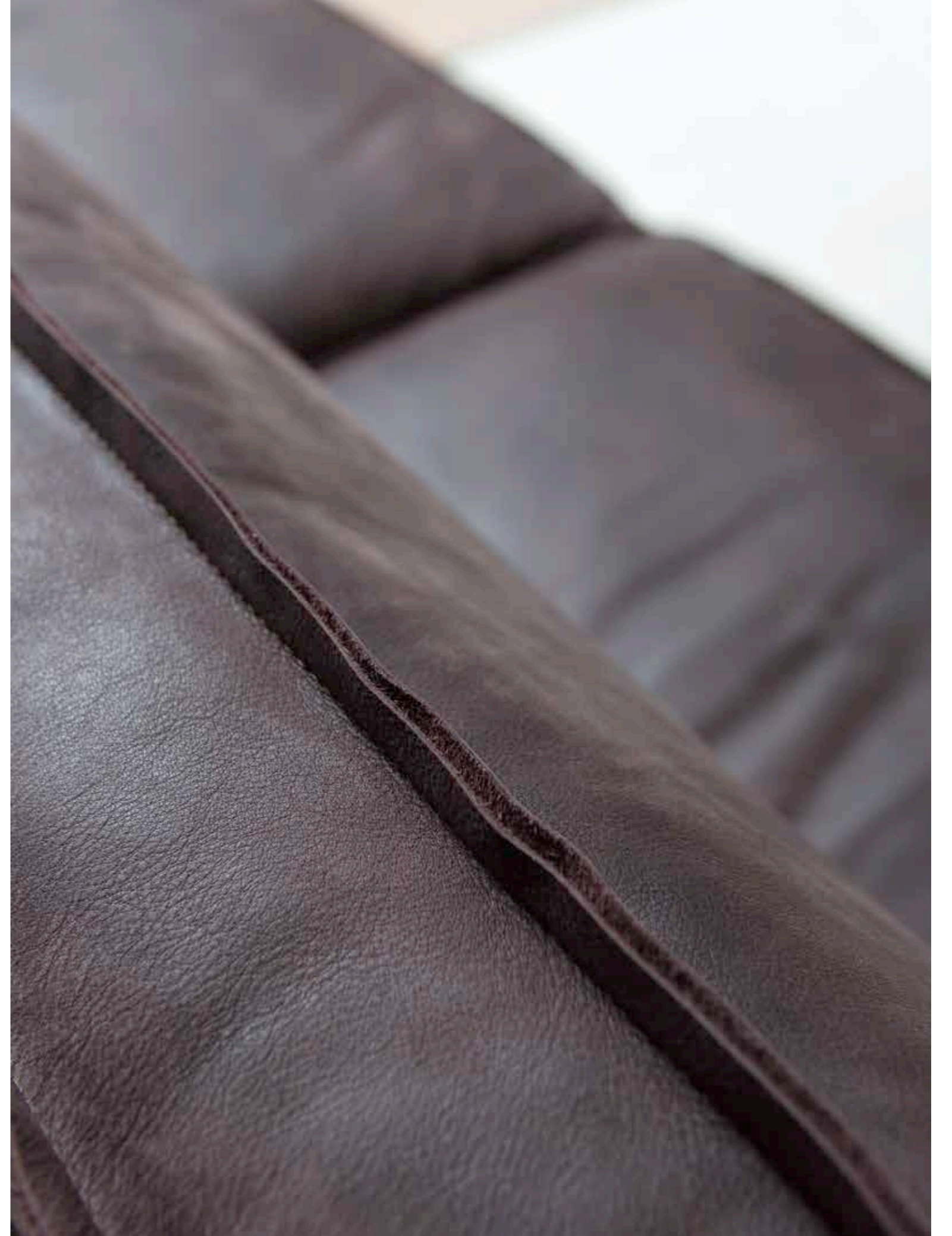



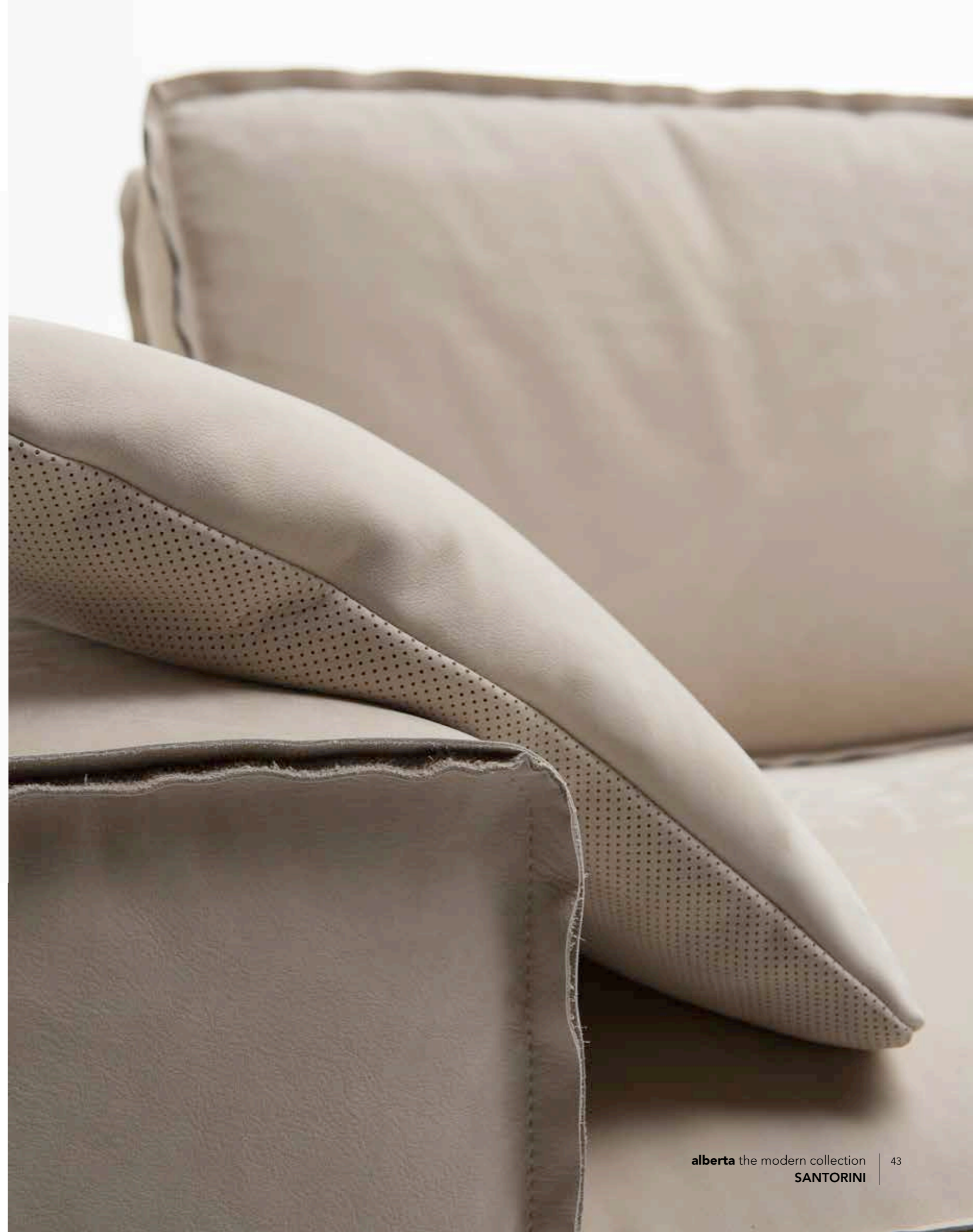



# SANTORINI DEEP

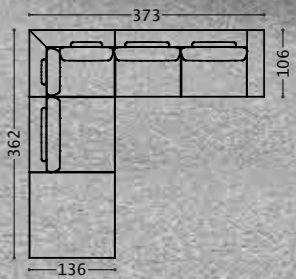
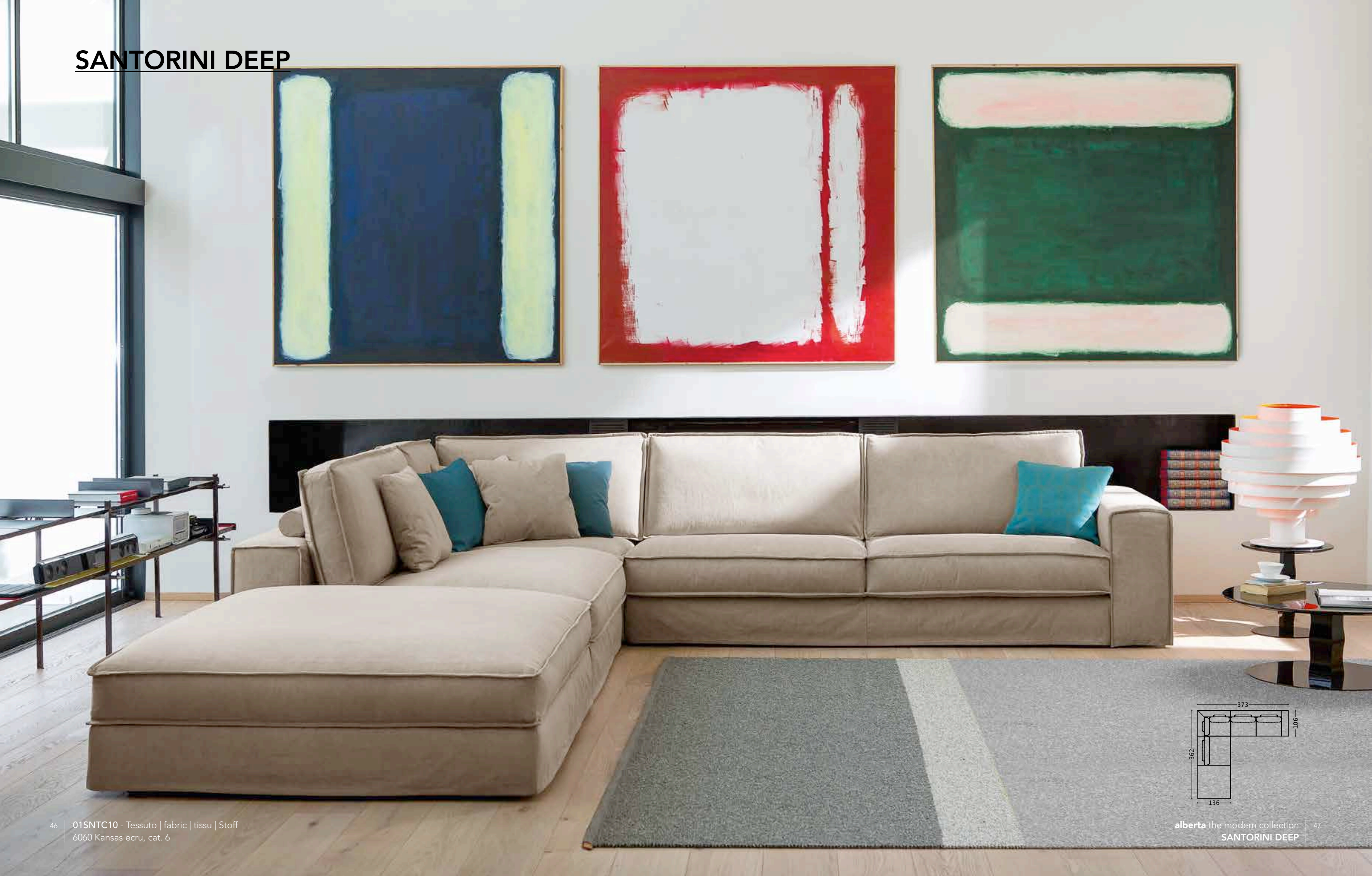

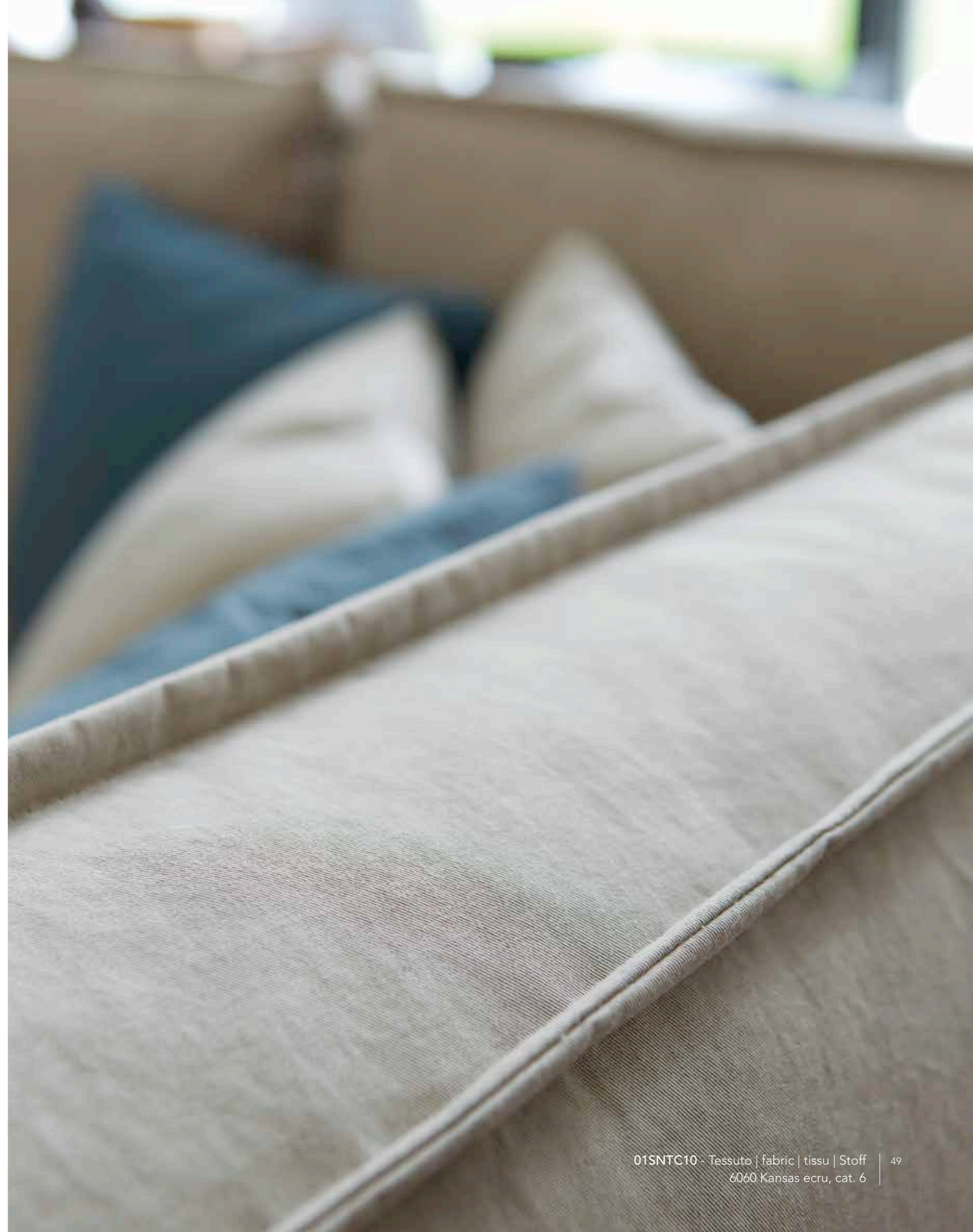

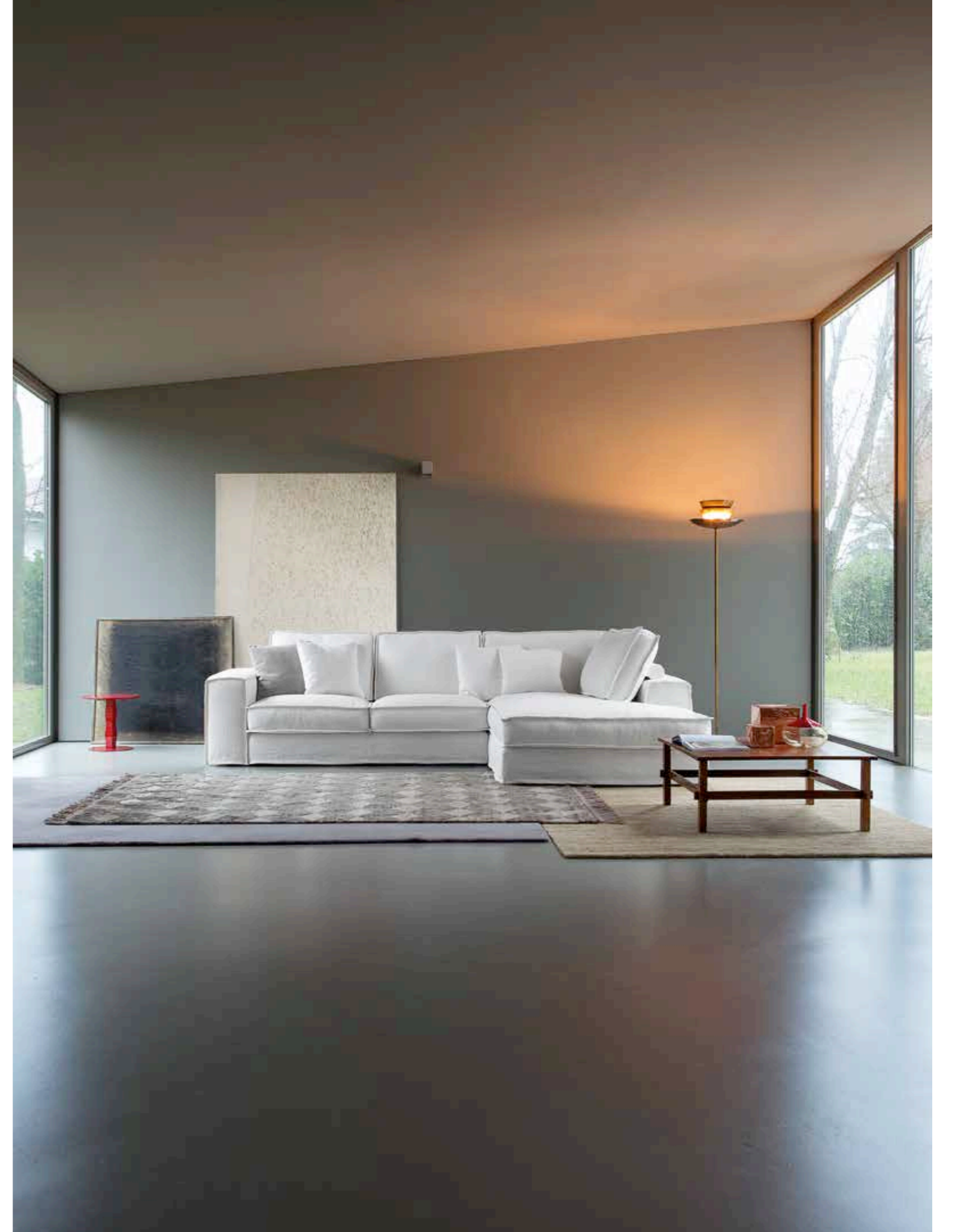













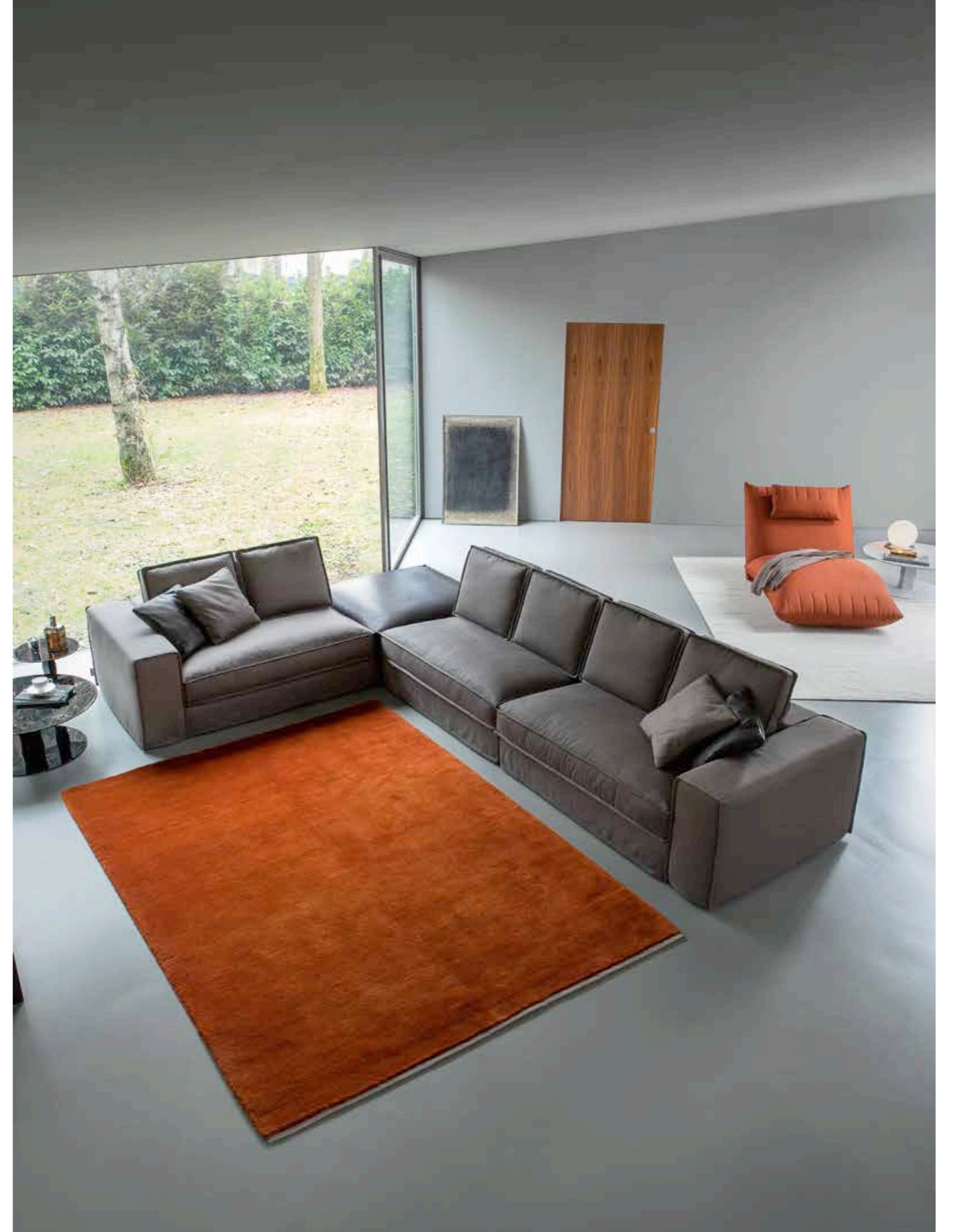





# SANTORINI DEEP



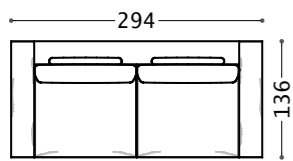

# BELLAVITA dormeuse

Disponibile con rivestimento in tessuto. Forme arrotondate (che richiamano dei guanciali) e trapuntature su seduta e schienale caratterizzano la nuova dormeuse modello Bellavita che va ad arricchire una gamma che comprende già diversi moduli, poltroncine e il letto disponibile in diverse soluzioni di testata. Lo schienale e la seduta sono in poliuretano espanso a densità differenziata. E' presente anche di serie un poggiatesta in piuma d'oca. I piedini nascosti donano leggerezza all'insieme.

Fabric covers. Soft and rounded shapes (that evoke pillows) and the quiltings on backrest and seat, characterize the new dormeuse Bellavita, which enriches a range that includes several modules, small armchairs and a bed available with different headboards. Backrest and seat are in polyurethane foam with different densities. The headrest in goose feathers is provided standard with the backrest. Looks like it's floating thanks to its concealed feet.

Disponibile avec revêtement en tissu. Des formes arrondies (qui rappellent des oreillers) et piquées sur l'assise et le dossier caractérisent la nouvelle dormeuse modèle Bellavita qui vient enrichir une gamme comprenant déjà différents modules, des fauteuils et un lit disponible avec différentes solutions de tête de lit. Le dossier et l'assise sont en mousse de polyuréthane à densité différenciée. Un appuie-tête en duvet d'oie est également présent en série. Les pieds flottants apportent de la légèreté à l'ensemble.

Verfügbar mit Stoffbezug. Abgerundete Formen im Einklang mit den Kopfkissen. Die Sitz- und Rückenpolsterungen sind mit Steppnähten versehen. Das neue Dormeuse-Modell Bellavita bereichert eine Produktreihe, in der neben verschiedenen Modulen und Armsesseln auch ein Bett mit diversen Kopfteil-Lösungen vertreten ist. Rücken- und Sitzpolsterung aus PU-Schaum mit unterschiedlicher Dichte. Das Modell BELLAVITA umfasst serienmäßig eine Kopfstütze mit Polsterung aus Gänsefedern. Die unsichtbaren Füße sorgen dafür, dass die Struktur schwerelos wirkt.

Technical data: p. 158









# THEO

Disponibile in pelle e tessuto. Le finiture e l'attenzione ai dettagli lo rendono un prodotto accattivante e dalla forte personalità. THEO risulta essere, quindi, un modello rassicurante per linee e comfort e allo stesso tempo grintoso e "fuori dagli schemi". La sua morbidezza contrasta con la linea grafica della cucitura che definisce le forme del divano e lo rende un modello prezioso e unico. La cucitura può essere a contrasto o tono su tono. L'elevato comfort è dato dall'imbottitura del cuscino di seduta e schienale in poliuretano espanso, piuma d'oca e fibra di poliestere e infine dal molleggio a cinghie elastiche. In gamma vi sono elementi con due braccioli, componibili - divani, poltrone, dormeuse e meridiana - e una gradevole poltroncina con braccioli più stretti rispetto ai divani. Gli elementi sono disponibili con rete elettrosaldata e materasso in poliuretano espanso ad alta densità. E' presente anche con bracciolo stretto (**THEO SLIM**). Il modello in pelle, inoltre, è disponibile anche nella versione senza gonna con bracciolo standard (**THEO 2**) o stretto (**THEO SLIM 2**).

Leather and fabric covers. The finishing and the attention to the details make it a product with a strong personality. THEO combines a softness image (thanks to its lines and comfort) with an unconventional taste. Its softness contrasts with the graphic line of the stitching which defines the shapes and makes it unique and precious. The stitching can be contrasting or "ton sur ton". The high comfort is given by seat and back cushions in polyurethane foam, goose feathers and polyester fiber and also by the elastic belts. The range of the model includes items with two armrests, sectional elements - sofas, armchairs, dormeuse, meridienne - and an attractive armchair with narrower armrests than the sofa. The sofas can be equipped with electrically-welded spring and high density polyurethane foam mattress. It's available also with a thin armrest (**THEO SLIM**). The Model in leather is available also without flowing cut with standard arm (**THEO 2**) or thin arm (**THEO SLIM 2**).

Recouvrement en cuir et tissu. Les finitions et l'attention aux détails en font un produit captivant à la forte personnalité. THEO est donc un modèle rassurant grâce à ses lignes et son confort, mais est en même temps dynamique et « hors norme ». Sa souplesse contraste avec le graphisme de la couture qui définit les formes du canapé et en fait un modèle précieux et unique. Coutures selliers, contrastées ou ton sur ton. Les coussins d'assise et de dos en mousse de polyuréthane, en plumes et en fibre polyester lui donnent un confort supérieur. Cette gamme comprend des éléments avec 2 accoudoirs, des éléments sectionaux, canapés, dormeuses, une méridienne et un fauteuil attractif avec des accoudoirs plus étroits que le canapé. Les éléments peuvent être prévus d'un sommier électrosoudé et matelas en mousse de polyuréthane haute densité. Le Theo est disponible avec accoudoir étroit (**THEO SLIM**). Le modèle en cuir est également disponible sans jupe avec accoudoir standard (**THEO 2**) ou accoudoir étroit (**THEO SLIM 2**).

Erhältlich in Leder und Stoff. Die Oberflächen und die Liebe zum Detail machen es zu einem attraktiven Produkt mit einer starken Persönlichkeit. THEO ist ein komfortables Modell mit vertrauten Linien, das zugleich aus den bekannten Schemen ausbricht. Seine Weichheit steht im Kontrast zu den grafischen Linien der Nähte, die die Form des Sofas definieren und macht es zu einem wertvollen und einzigartigen Modell. Die Nähte können Ton in Ton oder kontrastierend gewählt werden. Der hohe Komfort wird durch die Polsterung der Sitzfläche und Rückenlehne aus Polyurethanschaum, Polyesterfasern, Gänsefedern und schließlich durch elastische Gurte erreicht. Die Serie ist kombinierbar und beinhaltet Elemente mit zwei Armlehnen - Sofas, Sessel, Chaiselongue und Meridienne - sowie einen schönen Sessel mit schmalen Armlehnen als die Sofas. Die Elemente sind mit Stahlfedern oder mit einer dichten Polyurethanschaum-Matratze verfügbar. Es ist auch eine Version mit schmalen Armlehnen (**THEO SLIM**) verfügbar. Das Ledermodell ist zudem auch in einer Version ohne Rock mit Standardarmlehne (**THEO 2**) oder mit schmaler Armlehne (**THEO SLIM 2**).

Disegni tecnici | Technical drawings p. 164 - 167





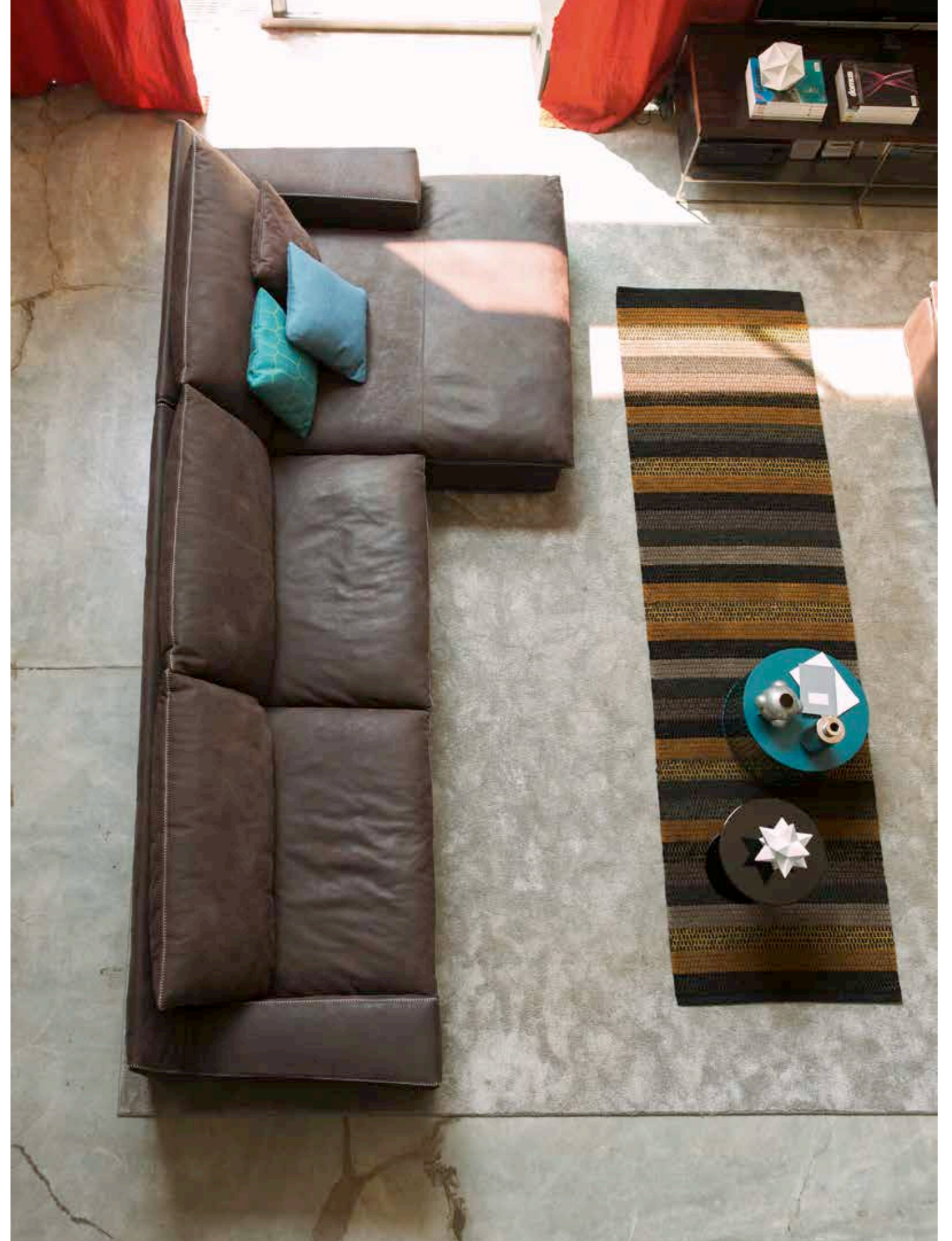





86 | PASHAKE40  
Tavolino laccatura lucida ø 40 cm / Coffee-table glossy laquering ø 40 cms



2THOD3M - Pelle | leather | cuir | Leder | 87  
959 Fjord ivoire, cat. G







90 PASHAKE80  
Tavolino laccatura lucida ø 80 cm / Coffee-table glossy laquering ø 80 cms



OTETC4 - Tessuto | fabric | tissu | Stoff | 91  
526D Mawi castoro, cat. 5



# THEO SLIM







# MIAMI

Disponibile in pelle e tessuto (**MIAMI 2**). Il modello Miami è un sistema modulare con linee morbide e ben definite. Solo la versione in pelle è caratterizzata da un'interessante trapuntatura sui cuscini di schienale e di seduta. L'elevato comfort è dato dall'imbottitura del cuscino di seduta e schienale in poliuretano espanso e fibra di poliestere e dal molleggio a cinghie elastiche. In gamma vi sono elementi con due braccioli e componibili - divani, poltrone, dormeuse e meridiana - e una gradevole poltroncina con braccioli più stretti rispetto ai divani. Gli elementi sono disponibili con rete elettrosaldata e materasso in poliuretano espanso ad alta densità. E' presente anche nella versione con bracciolo stretto (**MIAMI SLIM-MIAMI SLIM 2**).

Leather and fabric covers (**MIAMI 2**). Miami is a modular system with smooth and well defined lines. The leather version only is characterized by an interesting quilting on the back and seat cushions. High comfort is given by seat and back cushions in polyurethane foam, polyester fiber and also by the elastic belts. The range includes items with two armrests, sectional elements - sofas, armchairs, dormeuse, meridienne - and an attractive armchair with narrower armrests than the sofa. The sofas are available with electrically-welded spring and high density polyurethane foam mattress. It's available also with a thin armrest (**MIAMI SLIM-MIAMI SLIM 2**).

Recouvrement en cuir et tissu. (**MIAMI 2**). Le modèle Miami est un système modulaire avec des lignes souples et bien définies. La version en cuir est fort intéressante grâce aux coussins d'assise et de dos capitonnés. Les coussins d'assise et de dos sont en mousse de polyuréthane et fibre polyester. La gamme comprend des éléments avec 2 accoudoirs, des éléments sectionaux, des canapés, des fauteuils, dormeuses, une méridienne et un fauteuil attractif avec des accoudoirs plus étroits que le canapé. Les éléments peuvent être prévus d'un sommier électrosoudé et matelas en mousse de polyuréthane haute densité. Le Miami est disponible avec accoudoir étroit (**MIAMI SLIM-MIAMI SLIM 2**).

Erhältlich in Leder und Stoff (**MIAMI 2**). Das Miami-Modell ist ein modulares System mit weichen und gut definierten Linien. Die Leder-Version zeichnet sich durch eine interessante Absteppung auf den Rücken- und Sitzkissen aus. Der hohe Komfort wird durch eine Polsterung der Sitzkissen und Rückenlehne aus Polyurethanschaum unterschiedlicher Dichte sowie durch elastische Gurte gegeben. Die Linie ist kombinierbar und beinhaltet Elemente mit zwei Armlehnen - Sofas, Sessel, Chaiselongue und Meridienne - Die Serie beinhaltet zudem ein schönen Sessel mit schmalen Armlehnen als die Sofas. Die Elemente sind mit Stahlfedern oder mit einer dichten Polyurethanschaum-Matratze verfügbar. Es ist auch eine Version mit schmalen Armlehnen (**MIAMI SLIM-MIAMI SLIM 2**) verfügbar.

Disegni tecnici | Technical drawings p. 168 - 171





**MIAMI SLIM**









## MIAMI 2





112 | 1MI2D3M - Tessuto | fabric | tissu | Stoff  
600A Linux greggio, cat. 6

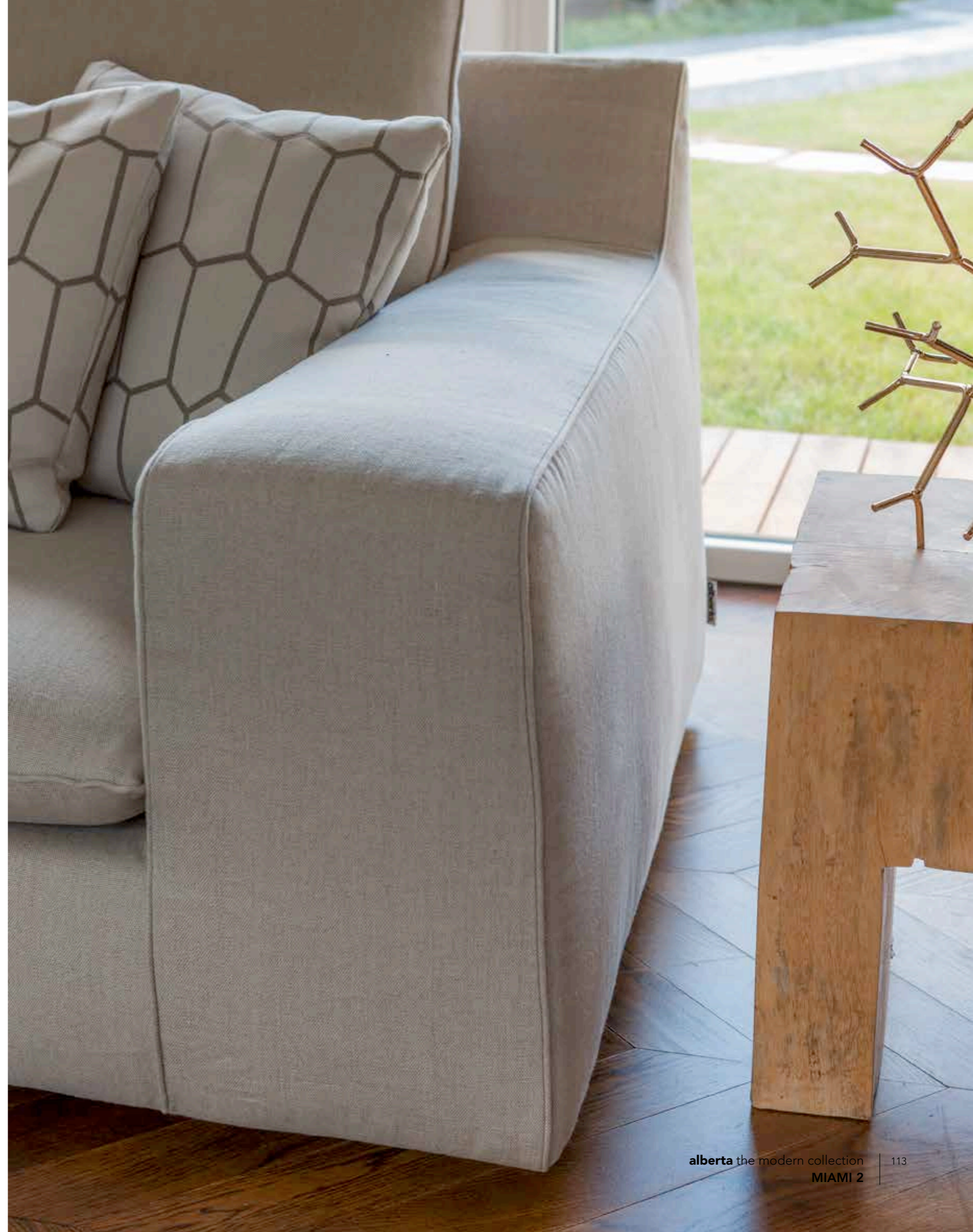

alberta the modern collection | 113  
MIAMI 2

# ROUTE 66

Disponibile con rivestimento in tessuto e pelle. Il modello Route 66 è caratterizzato da una struttura sottile, elegante e discreta, che circonda e contiene i morbidi ed avvolgenti cuscini di seduta. La scocca dal design definito, crea uno stile borghese e raffinato che si relaziona gradevolmente con il comfort della seduta. Lo schienale e la seduta sono in poliuretano espanso e piuma d'oca. La gamma comprende elementi con due braccioli e componibili e presenta anche una gradevole poltroncina. Il piedino standard ha un'altezza pari a cm. 10 cm mentre quello opzionale è a staffa, h. 14 cm che ne differenzia il comfort. Piede standard e a staffa sono disponibili con finitura cromata o verniciati grigio opaco.

Fabric and leather covers. Route 66 model has a very slender, elegant and discreet chassis that envelopes and holds the luxuriously soft seat cushions. The distinctive chassis creates a gentile and refined style that is perfectly balanced with its seat comfort. Backrest and seat are in polyurethane foam and goose feathers. The range includes sectional elements, items with two armrests and also an attractive armchair. The standard feet are 10 cms h., the optional stirrup feet, h. 14 cms give a different comfort to the model. Both standard and stirrup feet are available with chromium or matt grey varnish finishing.

Disponible avec revêtement en tissu et en cuir. Le modèle Route 66 est caractérisé par une structure fine, élégante et discrète, qui entoure et contient les coussins d'assise moelleux et enveloppants. La coque au design défini crée un style bourgeois et raffiné qui se marie agréablement avec le confort de l'assise. Le dossier et l'assise sont en mousse de polyuréthane et en duvet d'oie. La gamme comprend des éléments avec deux accoudoirs et modulaires ainsi qu'un agréable fauteuil. Le pied standard a une hauteur de 10 cm alors que le pied sur support est en option avec une hauteur de 14 cm qui accentue son confort. Le pied standard et le support sont disponibles avec une finition chromée ou laquée gris mat.

Verfügbar mit Leder- und Stoffbezug. Dieses Modell besticht durch seine feine, elegante und unaufdringliche Struktur mit weichen und anschmiegsamen Sitzpolstern. Die Struktur mit markantem Design sorgt für ein bürgerliches Flair, das auf ansprechende Weise mit dem Komfort der Sitzfläche harmonisiert. Rücken- und Sitzpolsterung aus PU-Schaum und Gänsefedern. Dieses Modell umfasst modulare Elemente mit zwei Armlehnen sowie einem gemütlichen Armsessel. Höhe der Standardfüsse: 10 cm. Als Option werden auch Bügelgestelle mit einer Höhe von 14 cm angeboten, die einen unterschiedlichen Komfort bietet. Sie sind in zwei Ausführungen erhältlich: verchromt oder mattgrau lackiert.

Technical data: p. 172 - 173

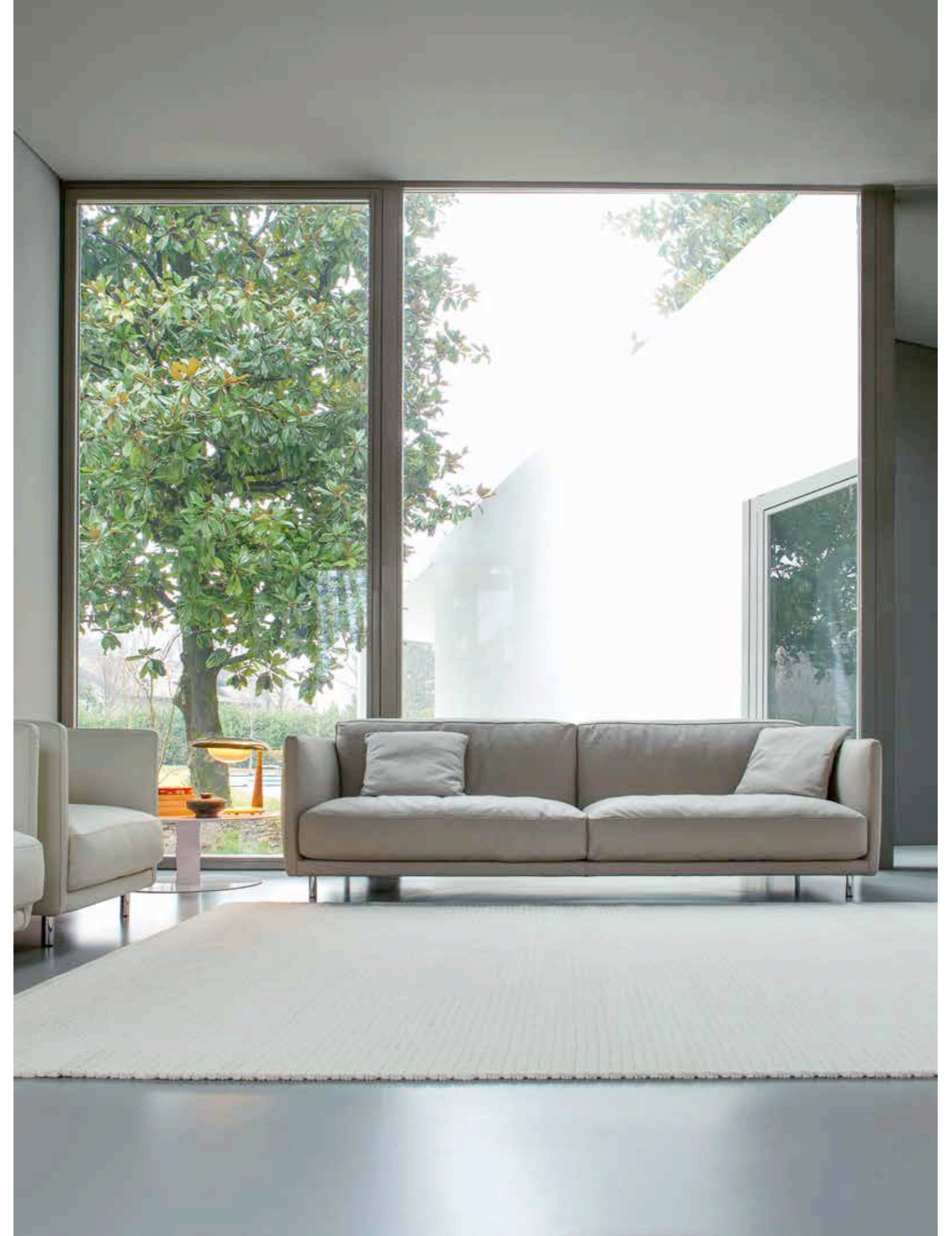













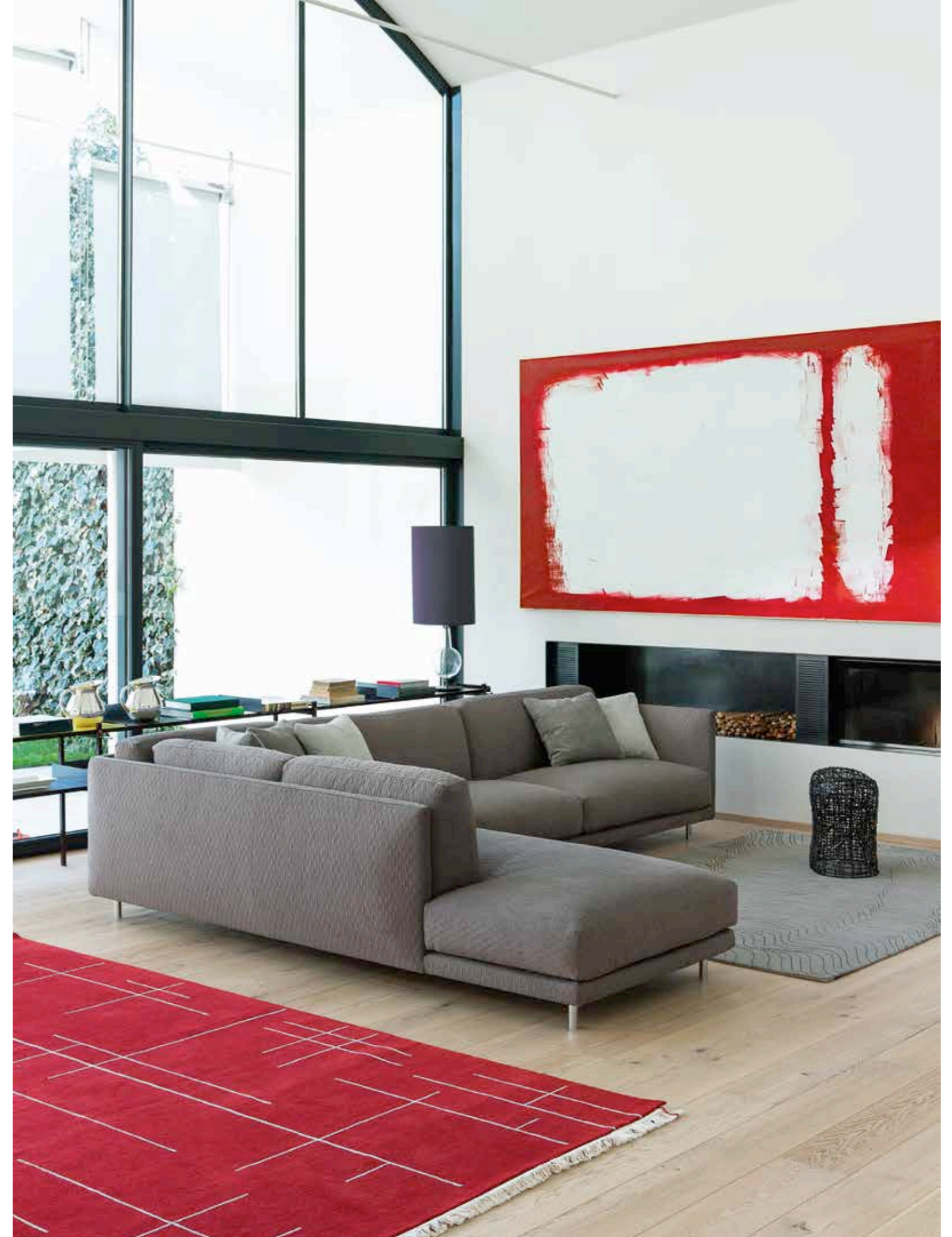







# BRIDGE

Disponibile in pelle e tessuto. Il modello Bridge si caratterizza per il design ricercato. E' sollevato da terra da piedini in metallo, h. 13 cm. I braccioli evidenziano la forma a martello dei cuscini di seduta e di schienale. Il taglio a vivo caratterizza il modello insieme alla forma a scaletta del fianco del bracciolo che dà a chi si siede una bella apertura verso l'esterno. L'elevato comfort è dato dall'imbottitura del cuscino di seduta e schienale in poliuretano espanso e fibra di poliestere, dai cuscini poggiatesta in piuma d'oca e fibra di poliestere e ancora dal molleggio a cinghie elastiche. In gamma vi sono elementi con due braccioli e componibili - divani, poltrone e dormeuse.

Leather and fabric covers. Bridge stands out for its refined design. It is raised off the floor by h. 13 cms metal feet. The armrests highlight the hammer shaped seat and back cushions. The open cut characterizes the sofa, together with the stepped shape of the armrest side, when someone is sitting on it gives a comfortable opening outwards. High comfort is given by seat and back in polyurethane foam and polyester fiber, backrest pillows in goose feathers and polyester fiber and also by the elastic belts. The range includes sectional elements and items with two armrests - sofas, armchairs and dormeuse.

Recouvrement en cuir et tissu. Design esthétique. Le canapé est flottant et plus haut grâce au pied en métal de 13 cm. Les accoudoirs accentuent les coussins d'assise et de dos en forme de marteau. La couture "bord à bord" caractérise le canapé ainsi que la forme à petits escaliers du bord de l'accoudoir qui donne à celui qui s'assied une belle ouverture vers l'extérieur. Les coussins d'assise et de dos en mousse de polyuréthane et fibre polyester ainsi que les coussins cale-reins en plumes et fibre polyester lui donnent son confort supérieur. La gamme contient des éléments sectionaux et à deux accoudoirs, des canapés et fauteuils et une dormeuse.

Erhältlich in Leder und Stoff. Das Modell Bridge zeichnet sich durch ein ausgewähltes Design aus. Durch 13cm hohe Metallfüße hebt es sich vom Boden ab. Die Armlehnen unterstreichen die Konturen der hammerförmigen Sitzkissen und Rückenissen. Der Rohschnitt charakterisiert das Modell zusammen mit der abgetreppten Seite der Armlehne, durch die sich das Modell nach außen hin öffnet. Der hohe Komfort wird durch die Polsterung der Sitzkissen und der Rückenlehne aus Polyurethanschaum mit unterschiedlicher Dichte sowie durch elastische Gurte gegeben. Die Serie ist kombinierbar und beinhaltet Elemente mit zwei Armlehnen - Sofas, Sessel und Chaiselongue.

Disegni tecnici | Technical drawings p. 174 - 175













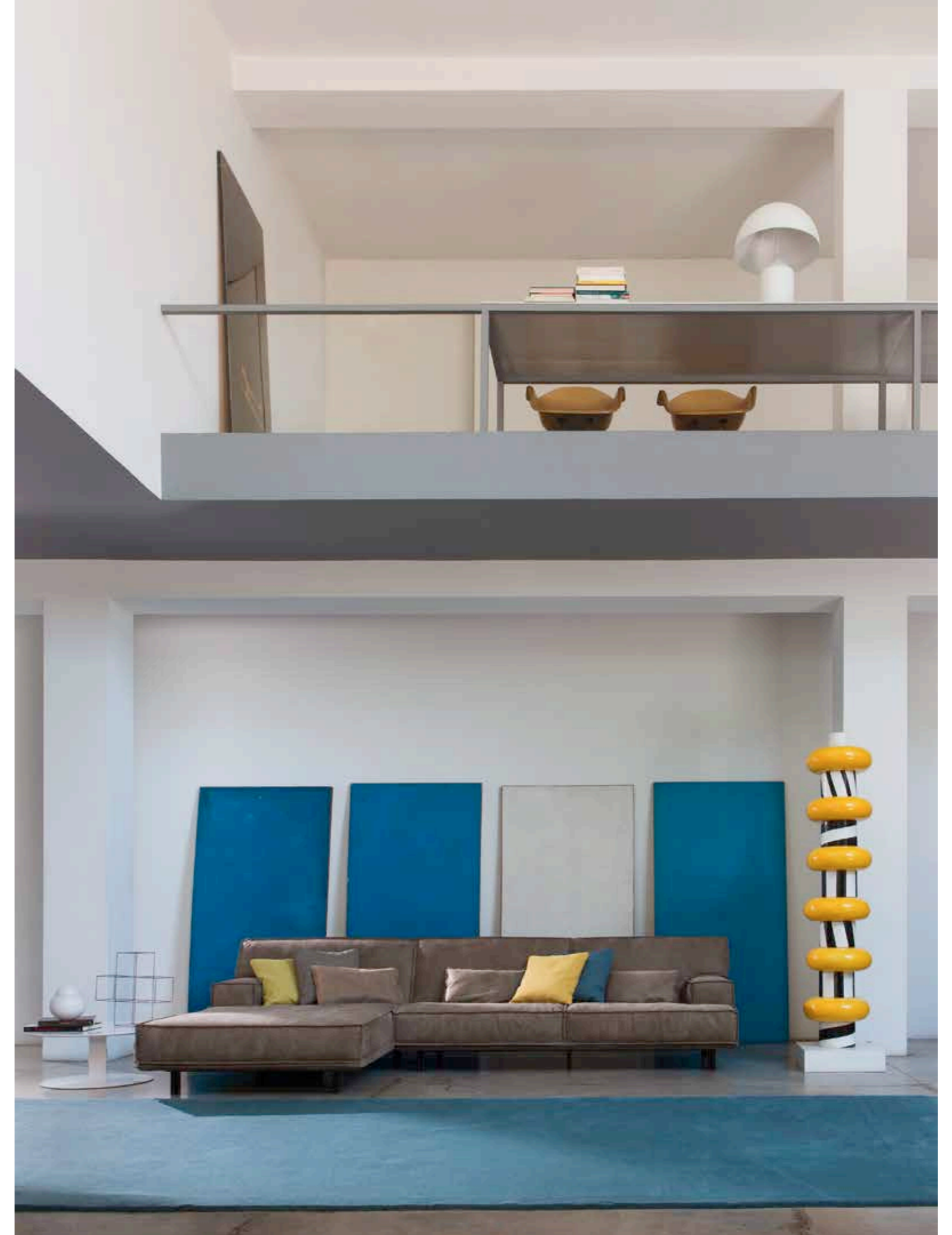

# SHAKE

Tavolino essenziale e stilisticamente definito, è contraddistinto da una gamba di forte impatto emotivo. Laccatura Lucida.

Minimalist coffee-table with striking stylish legs. Glossy laquering.

Table basse essentielle élégante. Se différencie par un pied avec un impact fort émotif. Disponible en divers coloris en laque.

Nüchterer Tisch mit klarem Stil, der sich durch einen Fuß mit starker optischer und emotionaler Wirkung auszeichnet. Poliertlack.

Disegni tecnici | Technical drawings p. 159

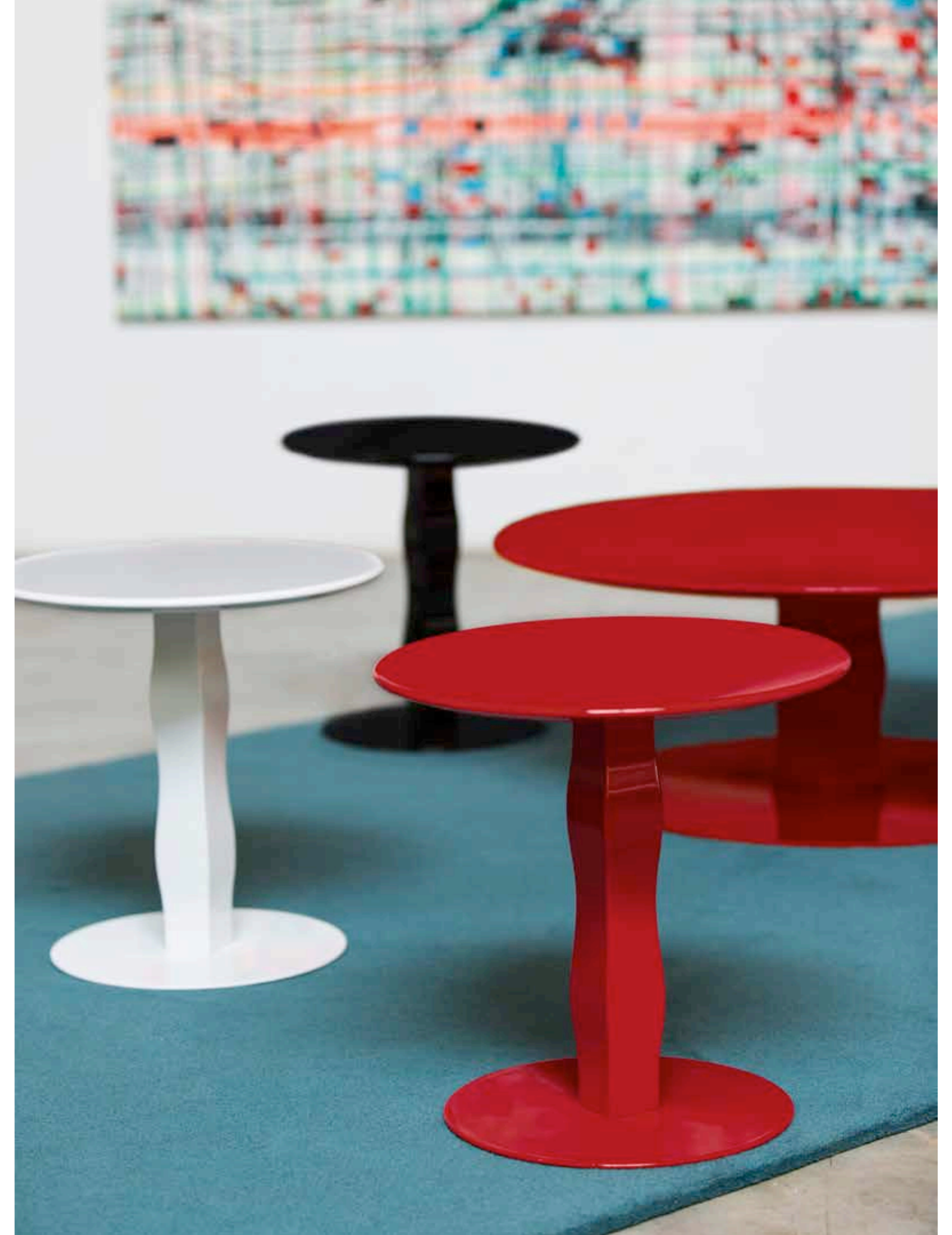

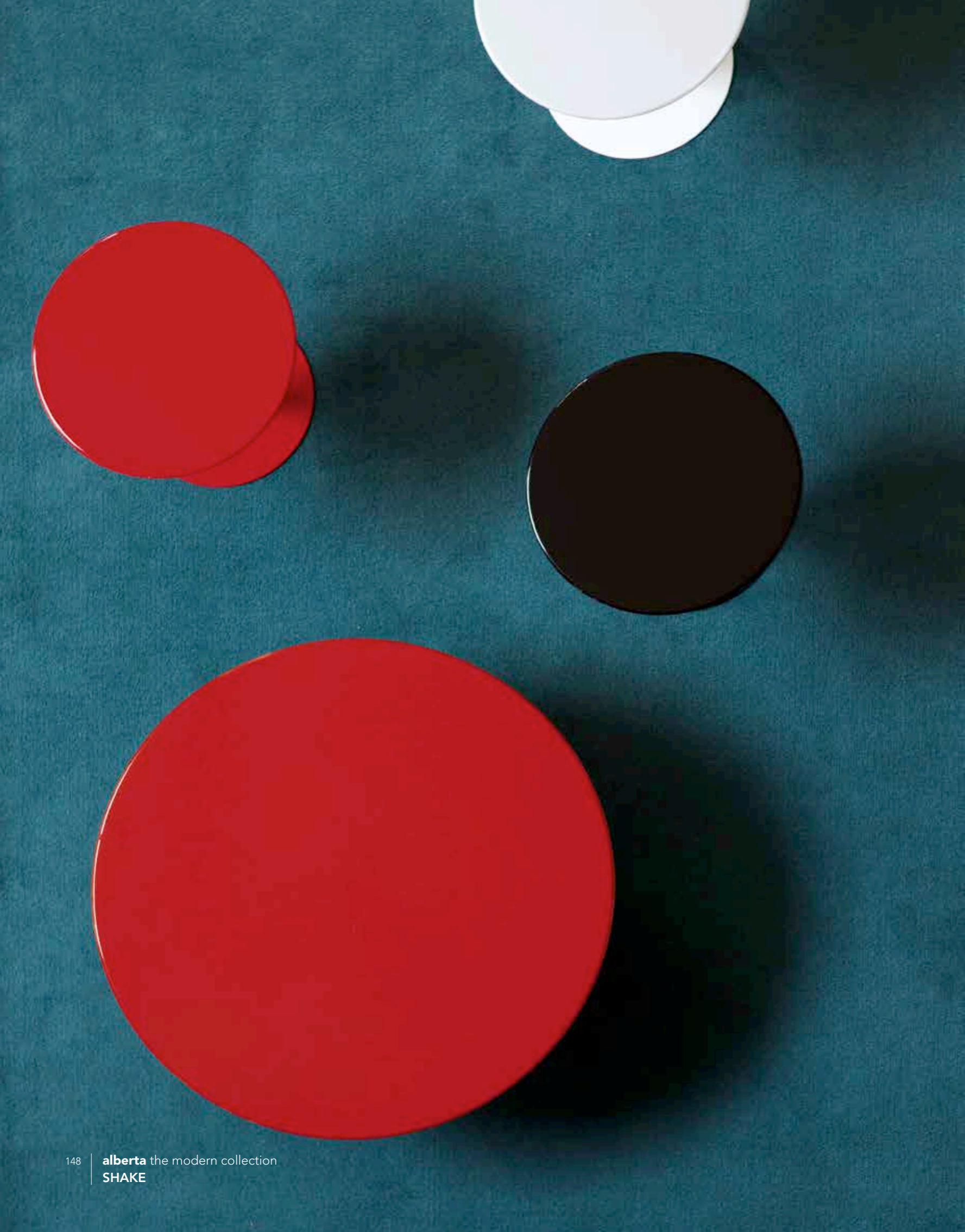

# UFO

Realizzata con materiali innovativi, UFO è una lampada dall'estrema leggerezza unita ad un'incredibile robustezza. Può essere utilizzata non solo come elemento illuminante ma anche come tavolino e comodino. Verrà fornita con certificazioni CE. Finitura lucida per il cappello e opaca per le gambe.

Manufactured with innovative materials, UFO is extremely light and at the same time a sturdy LED lamp that becomes also a coffee and a bedside table. It will be supplied with CE certificates. Glossy laquering for the top of lamp and matt lacquering for legs.

UFO, réalisée en matériaux innovateurs, est une lampe extrêmement légère, unie à une incroyable robustesse qui permet de l'utiliser non seulement comme élément d'éclairage mais aussi comme chevet. Elle est fournie d'un certificat CE. Laquage brillant pour le chapeau de la lampe et laquage mat pour les jambes.

Die aus innovativen Materialien realisierte Lampe UFO ist äußerst leicht und gleichzeitig unglaublich robust und kann nicht nur als Beleuchtungselement (LED-Beleuchtung), sondern auch als Nachttisch verwendet werden. Wird mit CE-Bescheinigungen geliefert. Glosslackiert für Lampenschirm und Mattlackiert für Ständer.

Disegni tecnici | Technical drawings p. 159

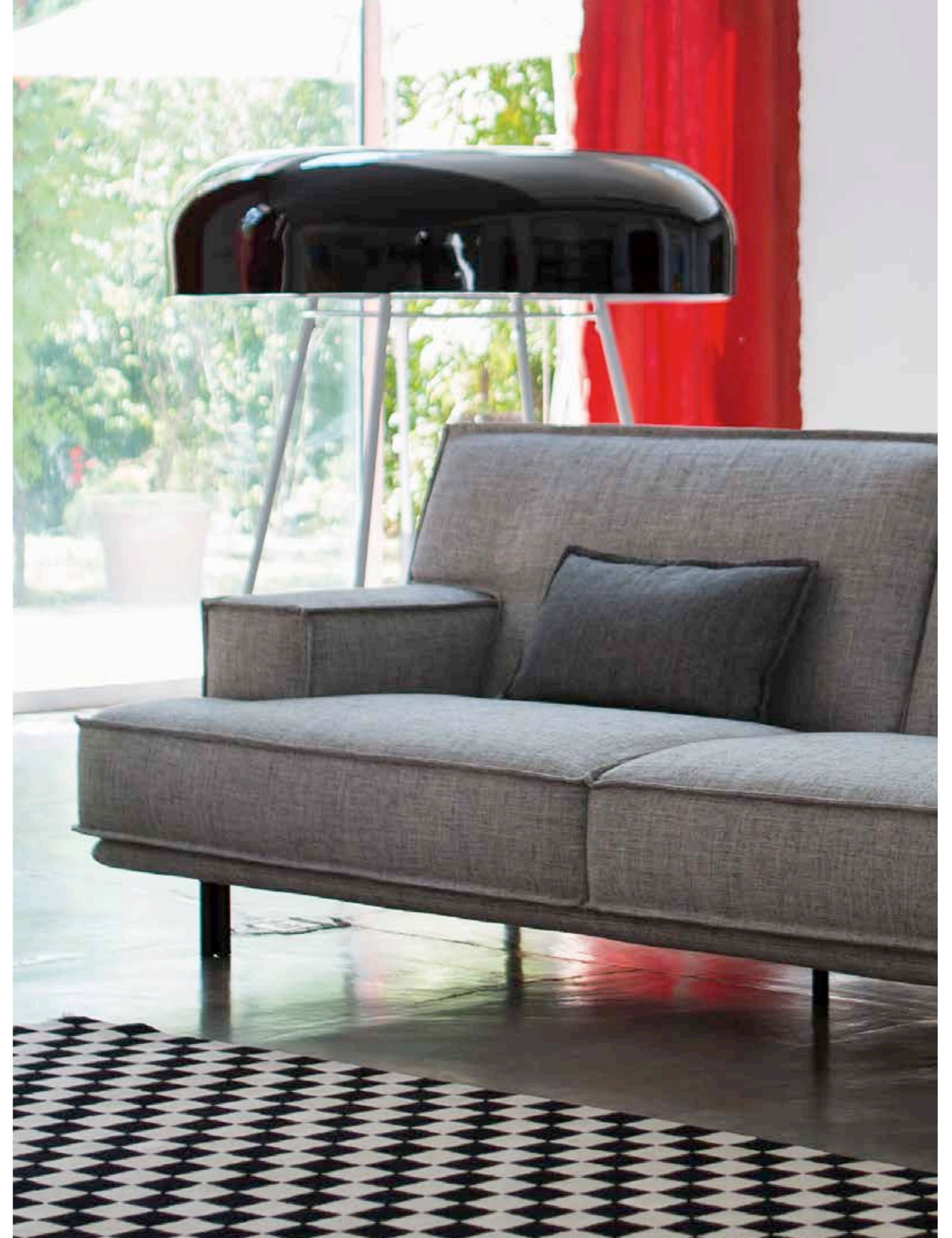







disegni tecnici  
*technical drawings*

**alberta**

# SIMON

Tessuto | fabric | tissu | Stoff



## COMPOSIZIONI/COMPOSITIONS/COMPOSITIONS/KOMPOSITIONEN

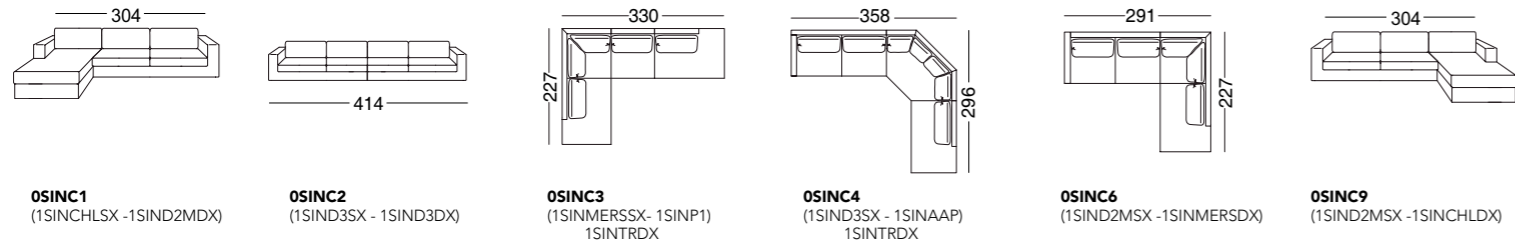

## ELEMENTI/ELEMENTS/ELEMENTS/ELEMENTE

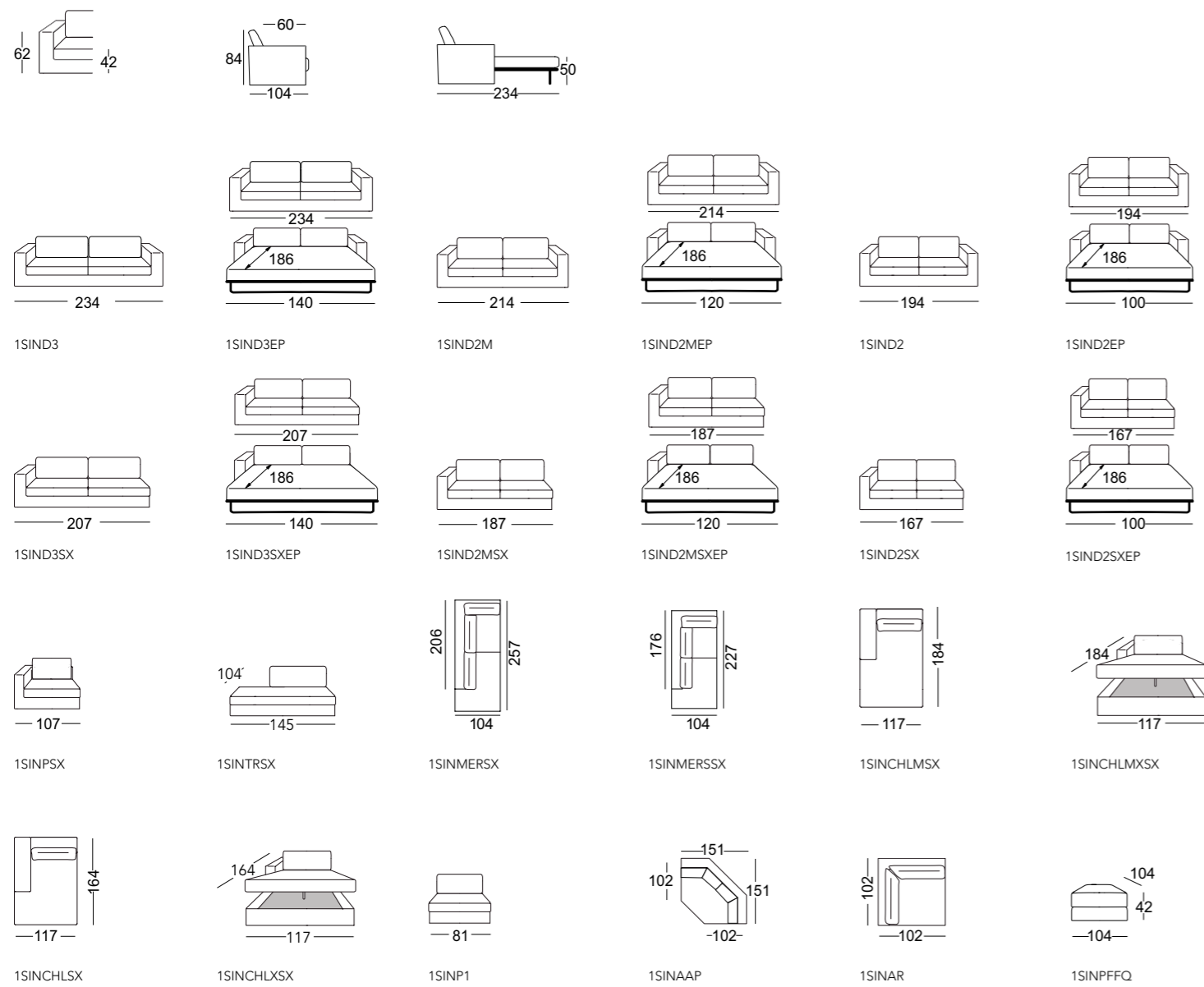

# HAMILTON

Tessuto | fabric | tissu | Stoff



## COMPOSIZIONI/COMPOSITIONS/COMPOSITIONS/KOMPOSITIONEN

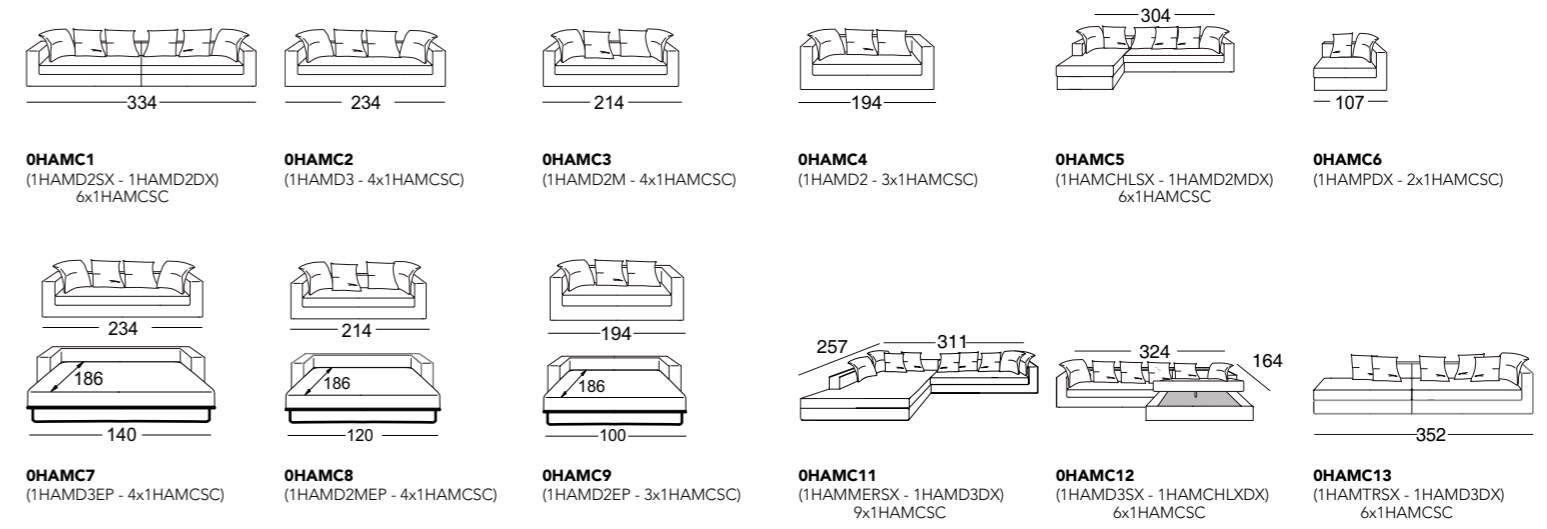

## ELEMENTI/ELEMENTS/ELEMENTS/ELEMENTE



## ELLE

Pelle | leather | cuir | Leder

ELEMENTI/ELEMENTS/ELEMENTS/ELEMENTE

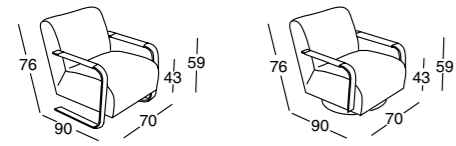

PMPPELL

PMGRPELL



## SHAKE

ELEMENTI/ELEMENTS/ELEMENTS/ELEMENTE

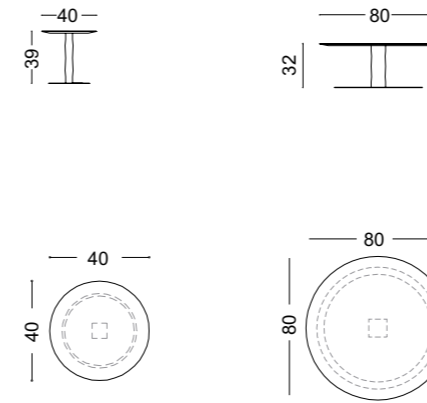

PASHAKE40

PASHAKE80



## BELLAVITA - dormeuse

Tessuto | fabric | tissu | Stoff

ELEMENTI/ELEMENTS/ELEMENTS/ELEMENTE

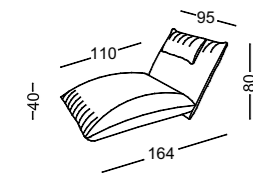

1BLVDORM

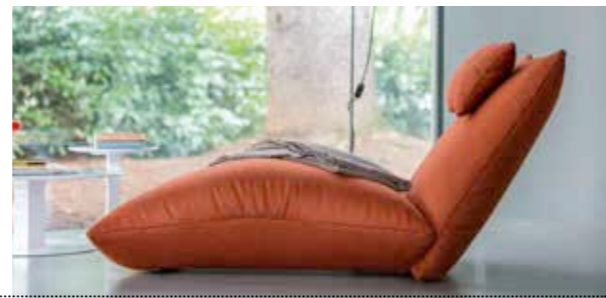

## UFO

ELEMENTI/ELEMENTS/ELEMENTS/ELEMENTE

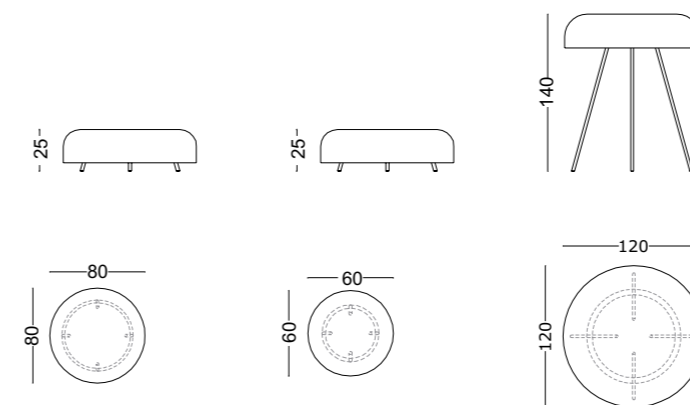

PALUFOLPBM

PALUFOLPBS

PALUFOLPAL



# SANTORINI

Pelle | leather | cuir | Leder



## COMPOSIZIONI/COMPOSITIONS/COMPOSITIONS/KOMPOSITIONEN

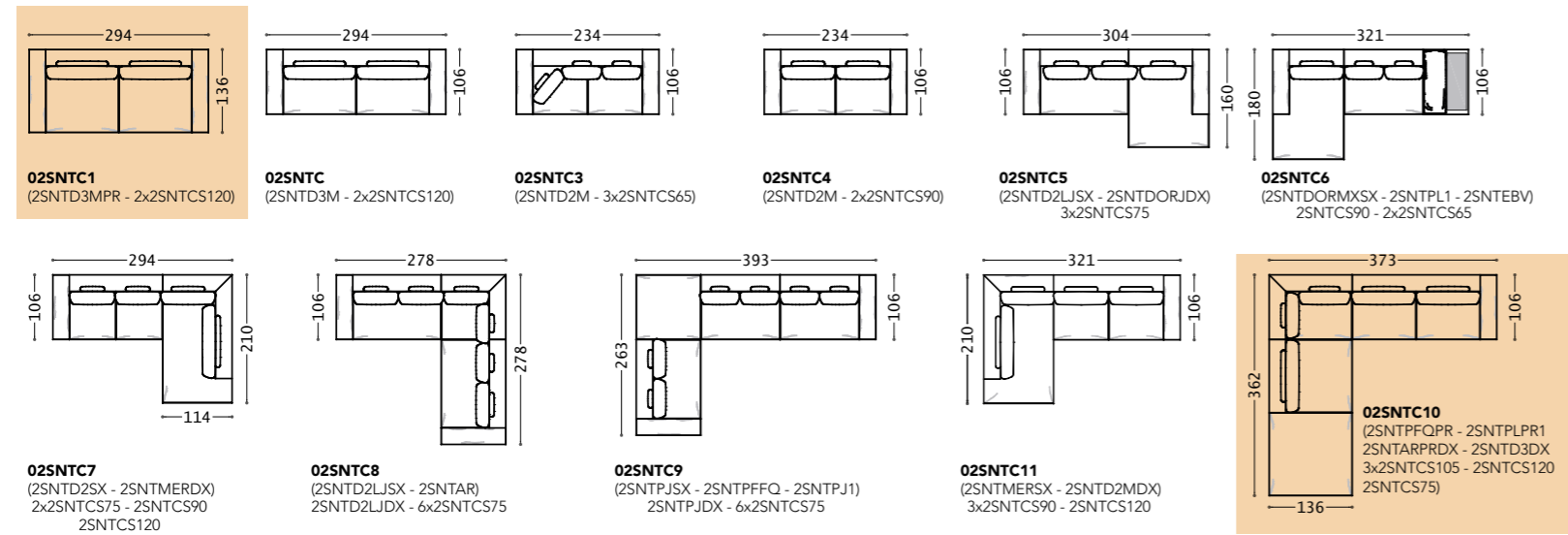

## ELEMENTI/ELEMENTS/ELEMENTS/ELEMENTE

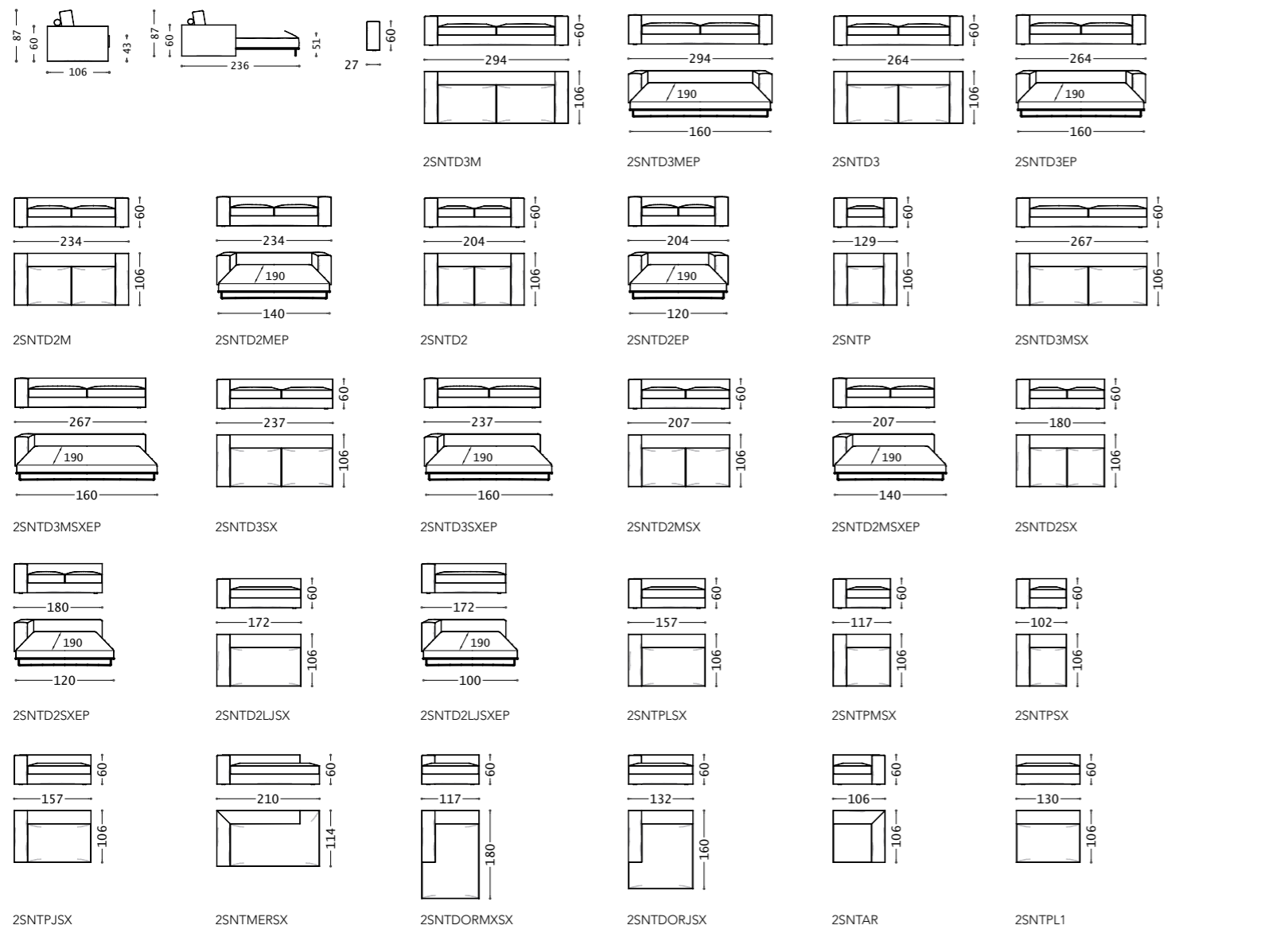

## ELEMENTI/ELEMENTS/ELEMENTS/ELEMENTE

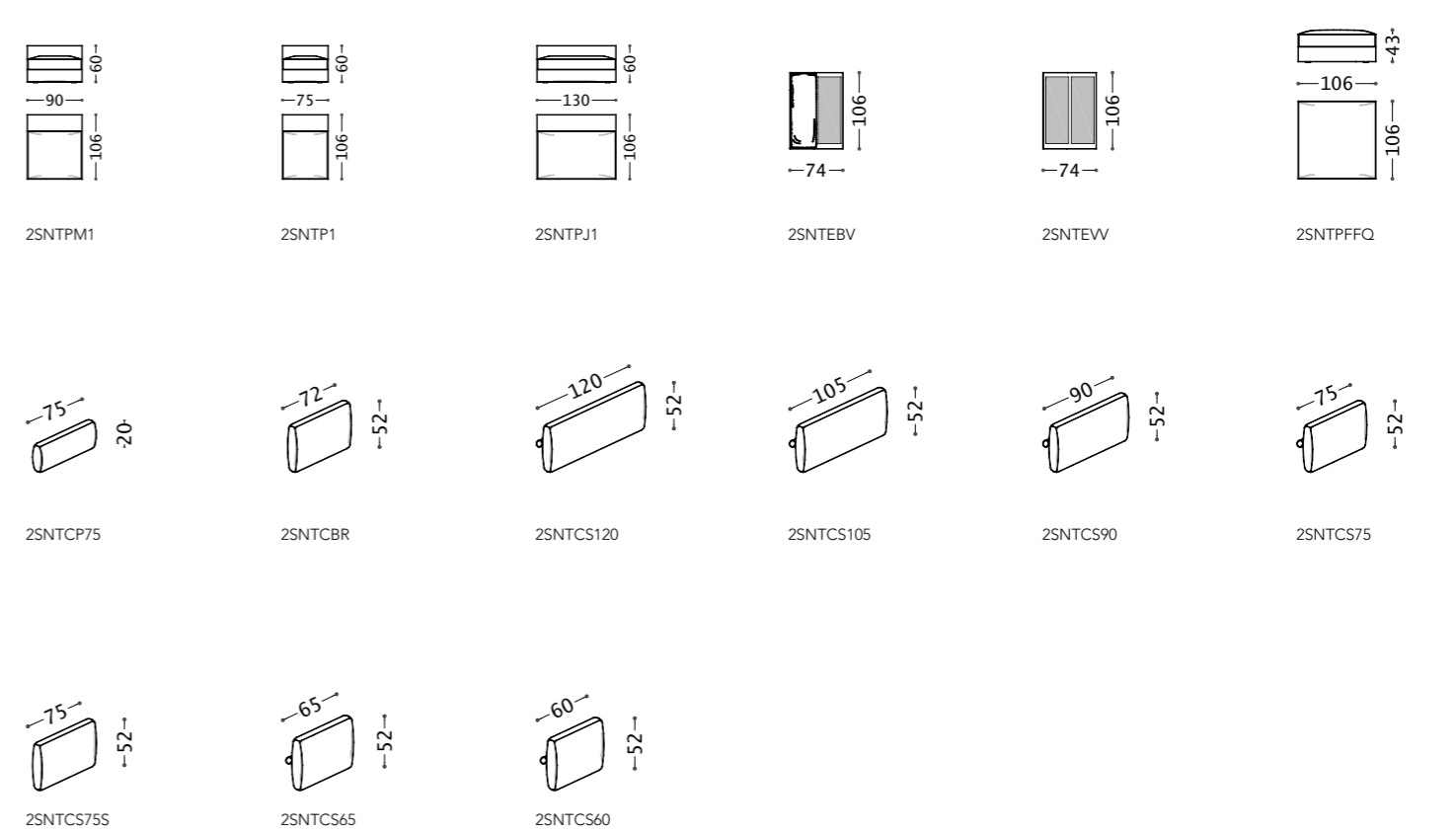

## ELEMENTI/ELEMENTS/ELEMENTS/ELEMENTE

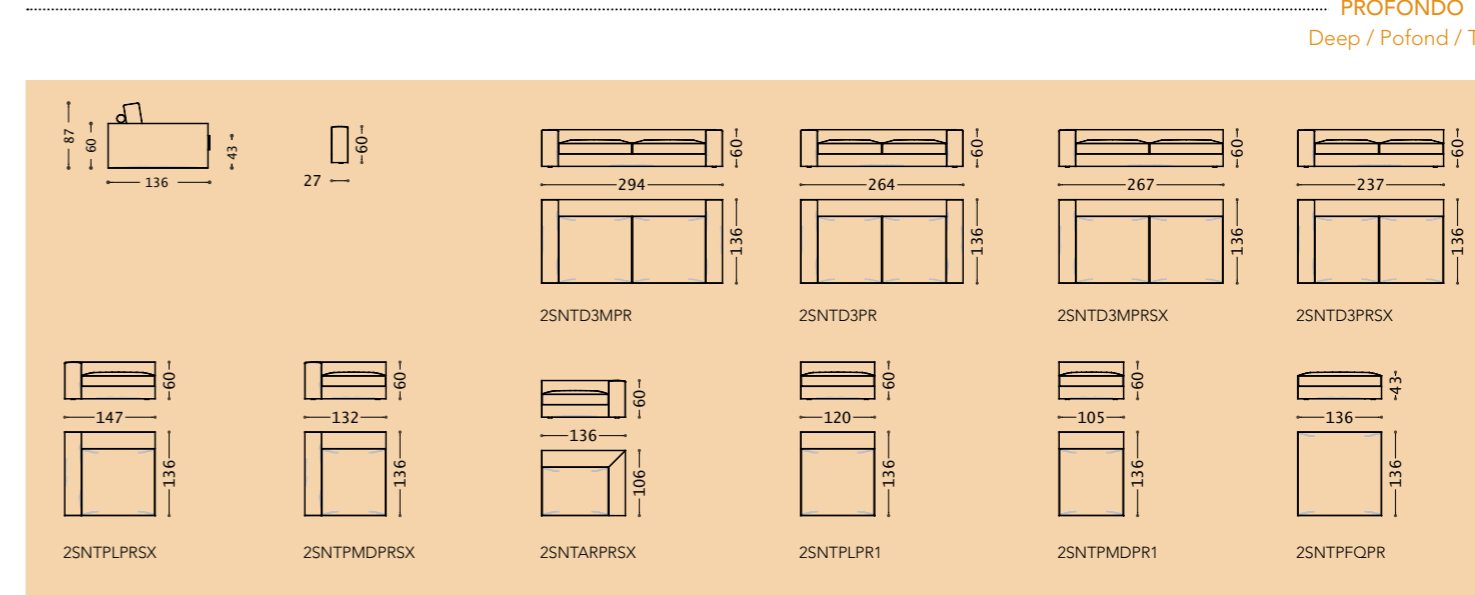

STANDARD

PROFONDO  
Deep / Pofond / Tief

# SANTORINI

Tessuto | fabric | tissu | Stoff



## COMPOSIZIONI/COMPOSITIONS/COMPOSITIONS/KOMPOSITIONEN

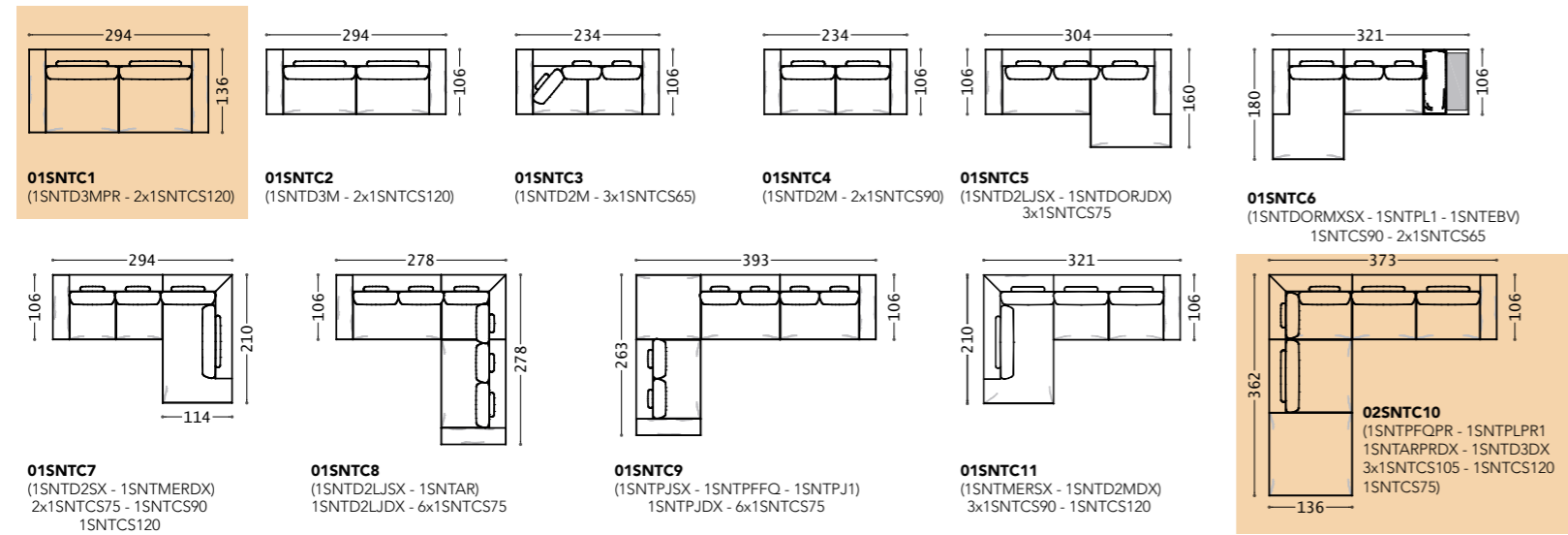

## ELEMENTI/ELEMENTS/ELEMENTS/ELEMENTE

STANDARD

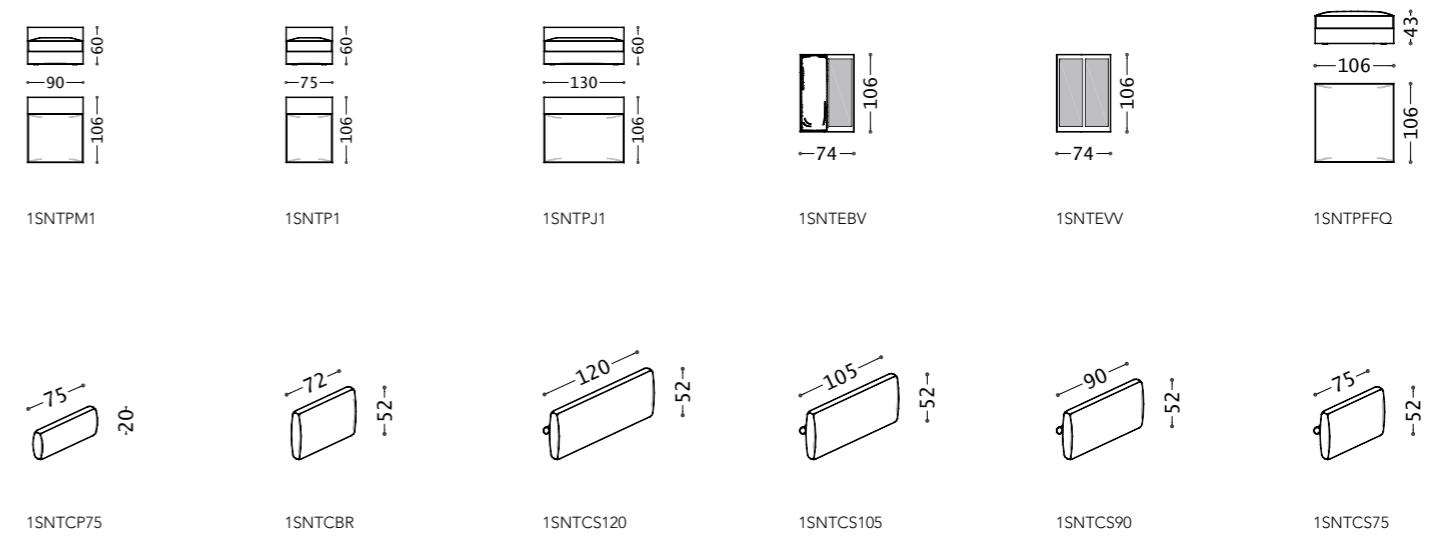

## ELEMENTI/ELEMENTS/ELEMENTS/ELEMENTE

STANDARD

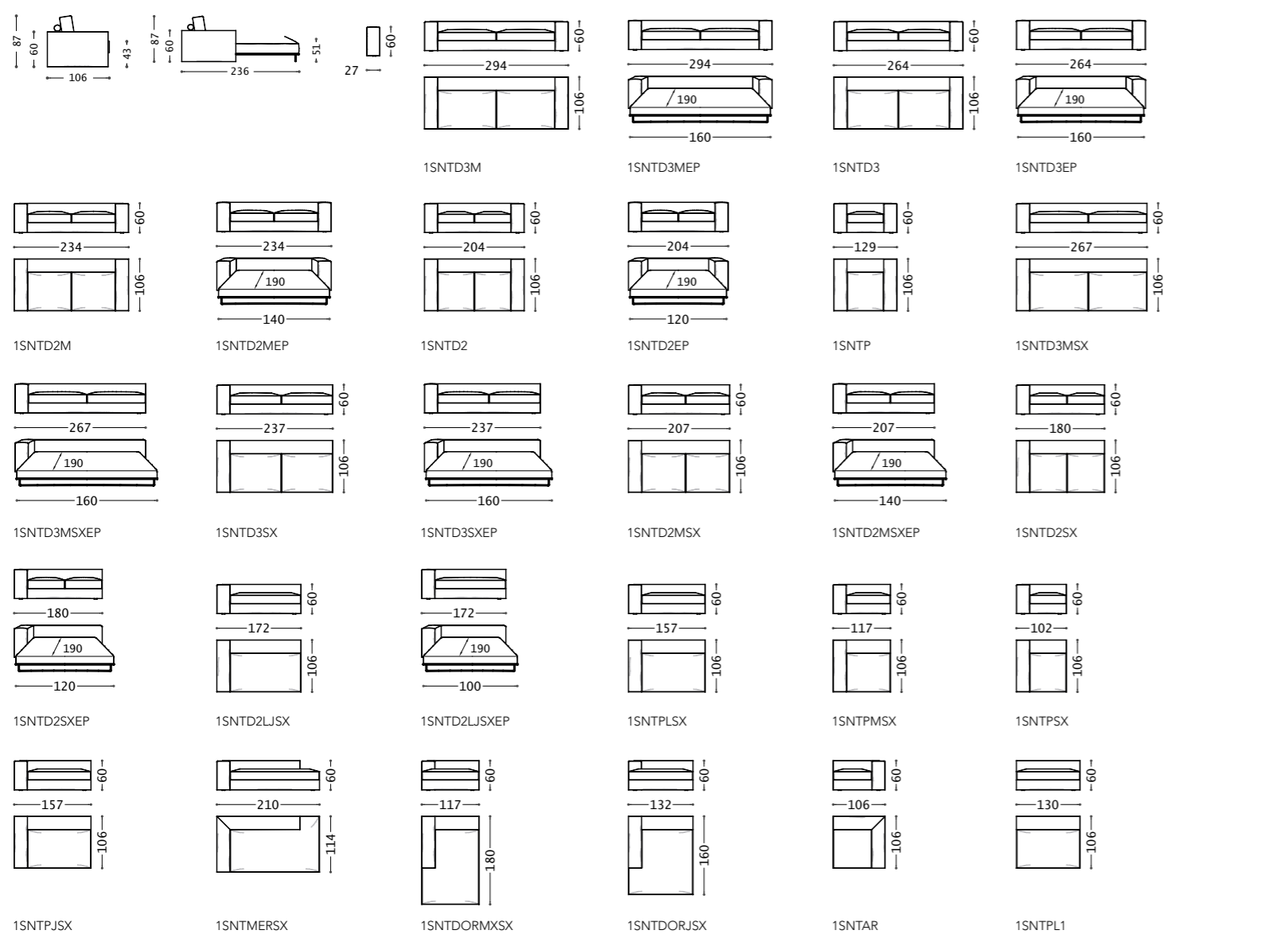

## ELEMENTI/ELEMENTS/ELEMENTS/ELEMENTE

PROFONDO  
Deep / Pofond / Tief

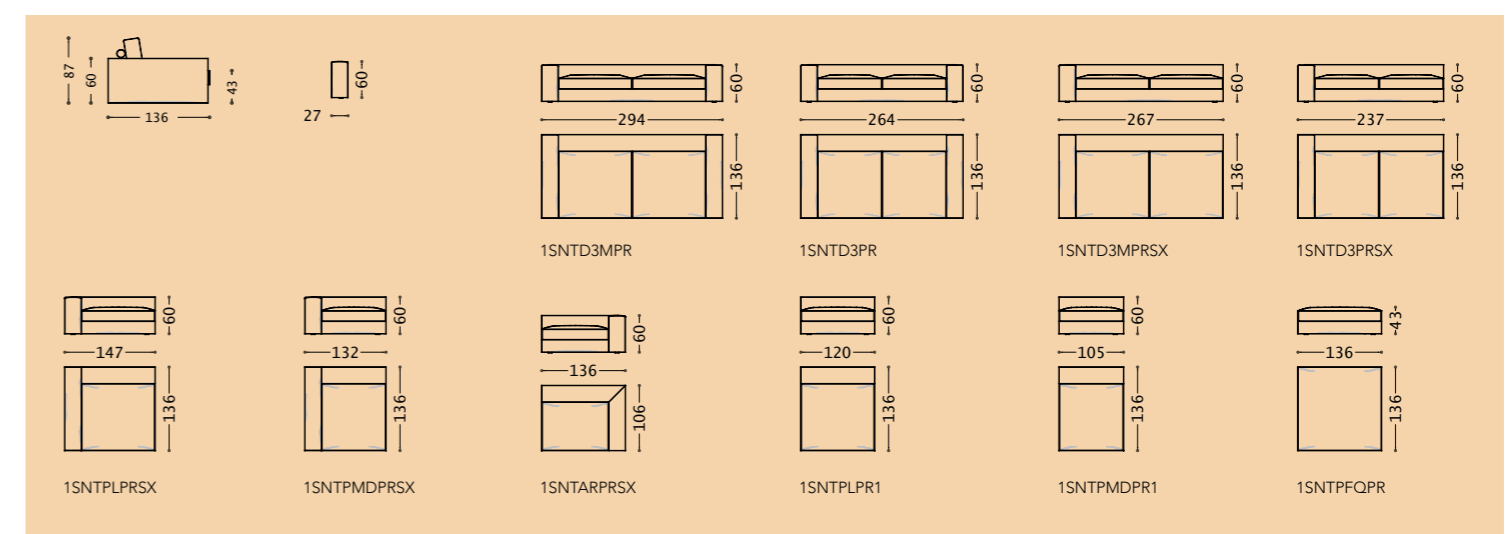

# THEO

Pelle | leather | cuir | Leder



COMPOSIZIONI/COMPOSITIONS/COMPOSITIONS/KOMPOSITIONEN

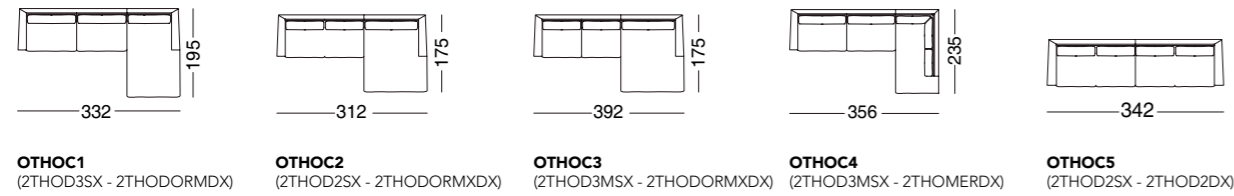

ELEMENTI/ELEMENTS/ELEMENTS/ELEMENTE

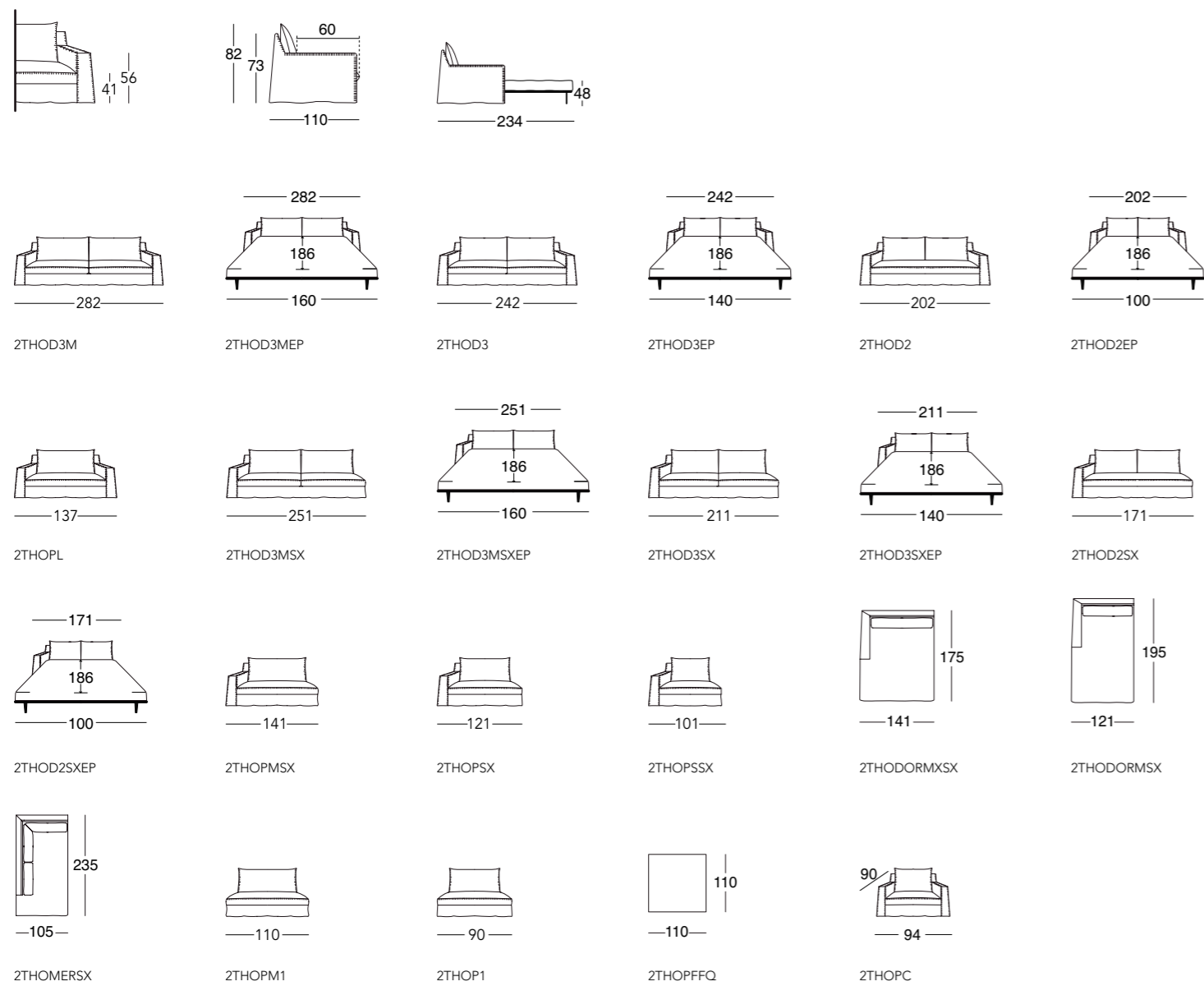

# THEO SLIM

Pelle | leather | cuir | Leder



COMPOSIZIONI/COMPOSITIONS/COMPOSITIONS/KOMPOSITIONEN

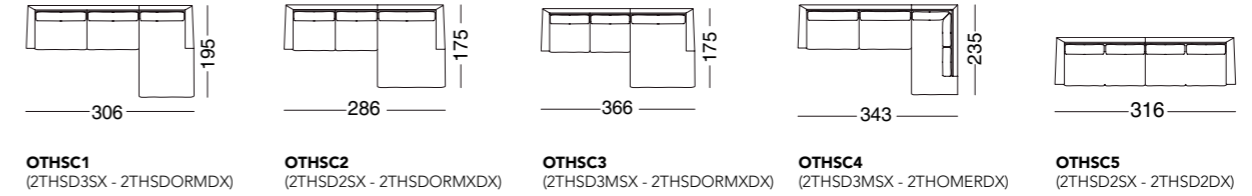

ELEMENTI/ELEMENTS/ELEMENTS/ELEMENTE

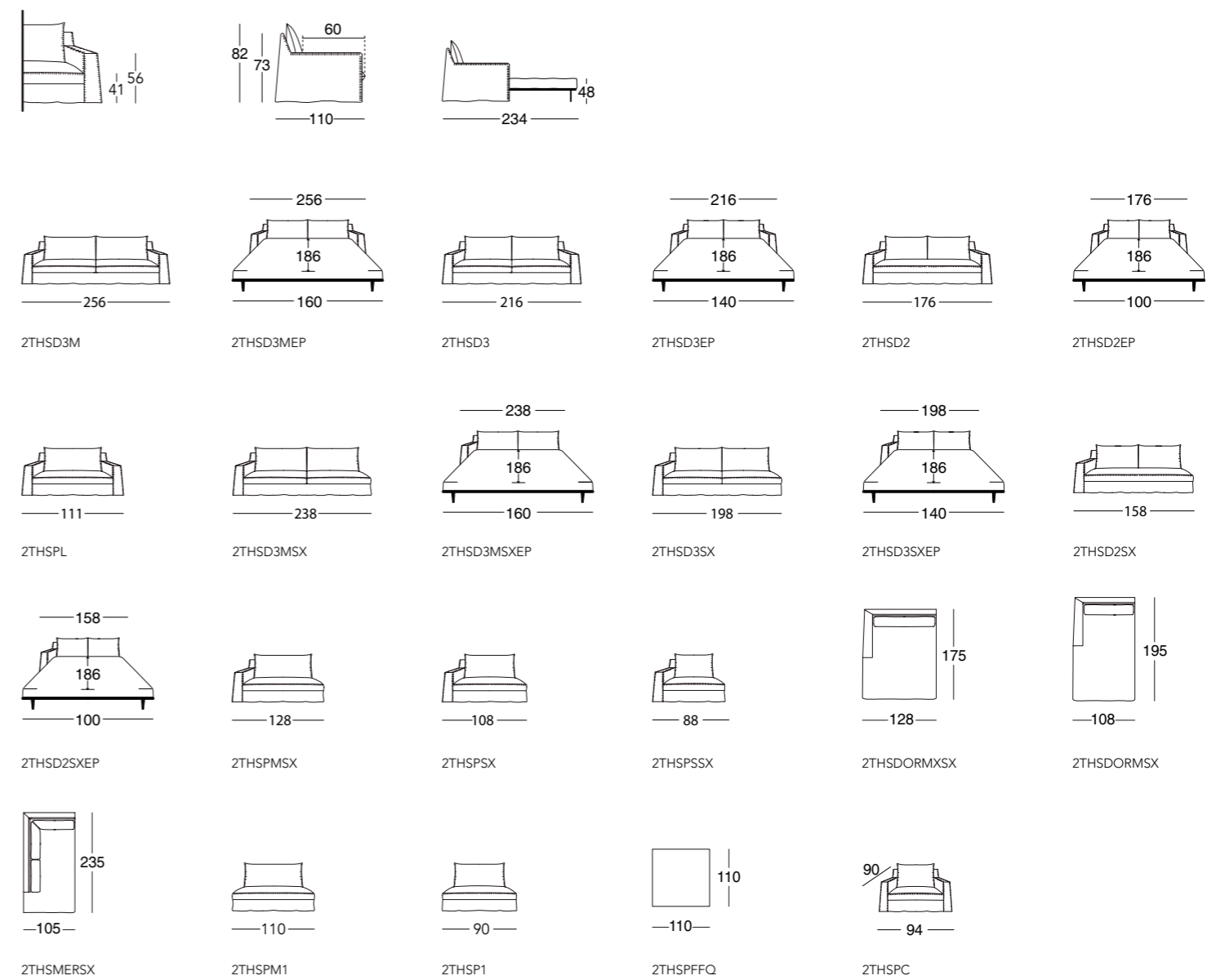

# THEO

Tessuto | fabric | tissu | Stoff



## COMPOSIZIONI/COMPOSITIONS/COMPOSITIONS/KOMPOSITIONEN

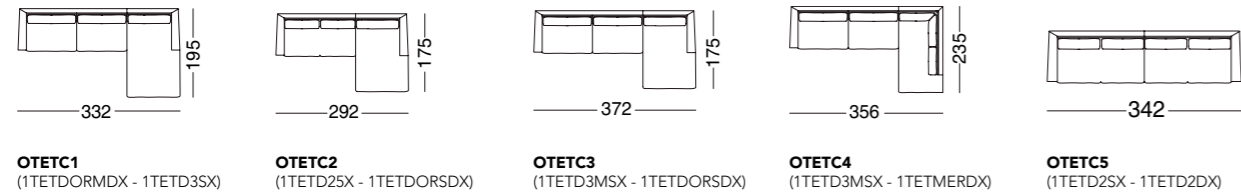

## ELEMENTI/ELEMENTS/ELEMENTS/ELEMENTE

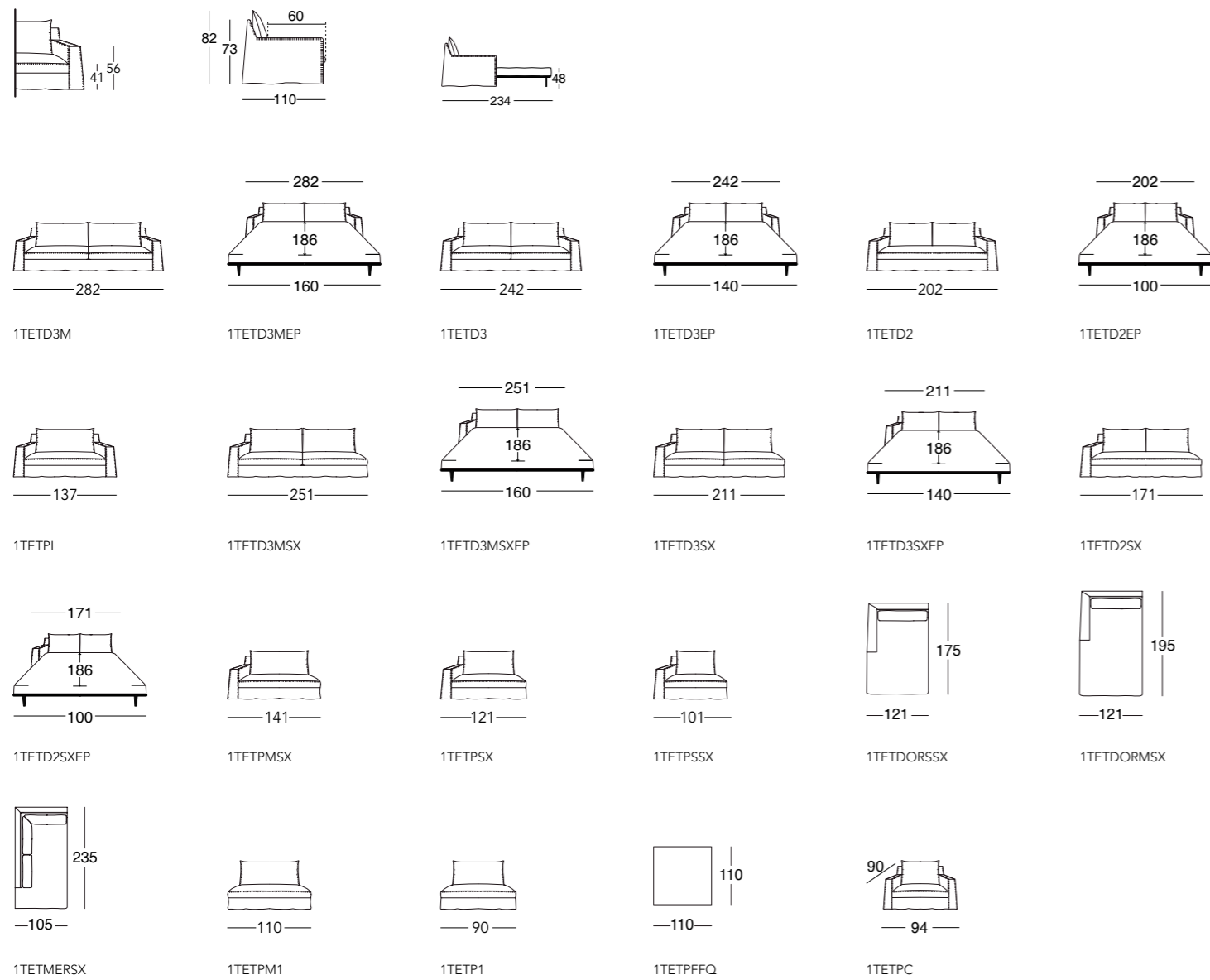

# THEO SLIM

Tessuto | fabric | tissu | Stoff



## COMPOSIZIONI/COMPOSITIONS/COMPOSITIONS/KOMPOSITIONEN

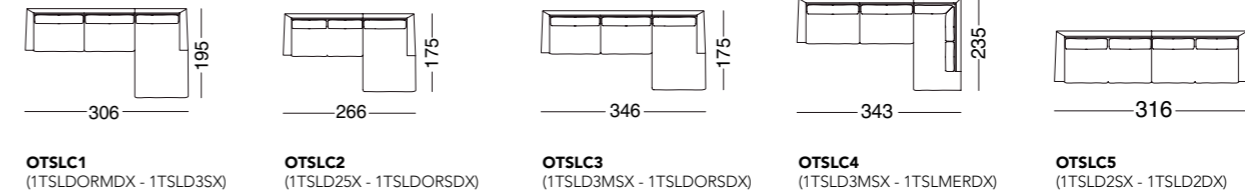

## ELEMENTI/ELEMENTS/ELEMENTS/ELEMENTE

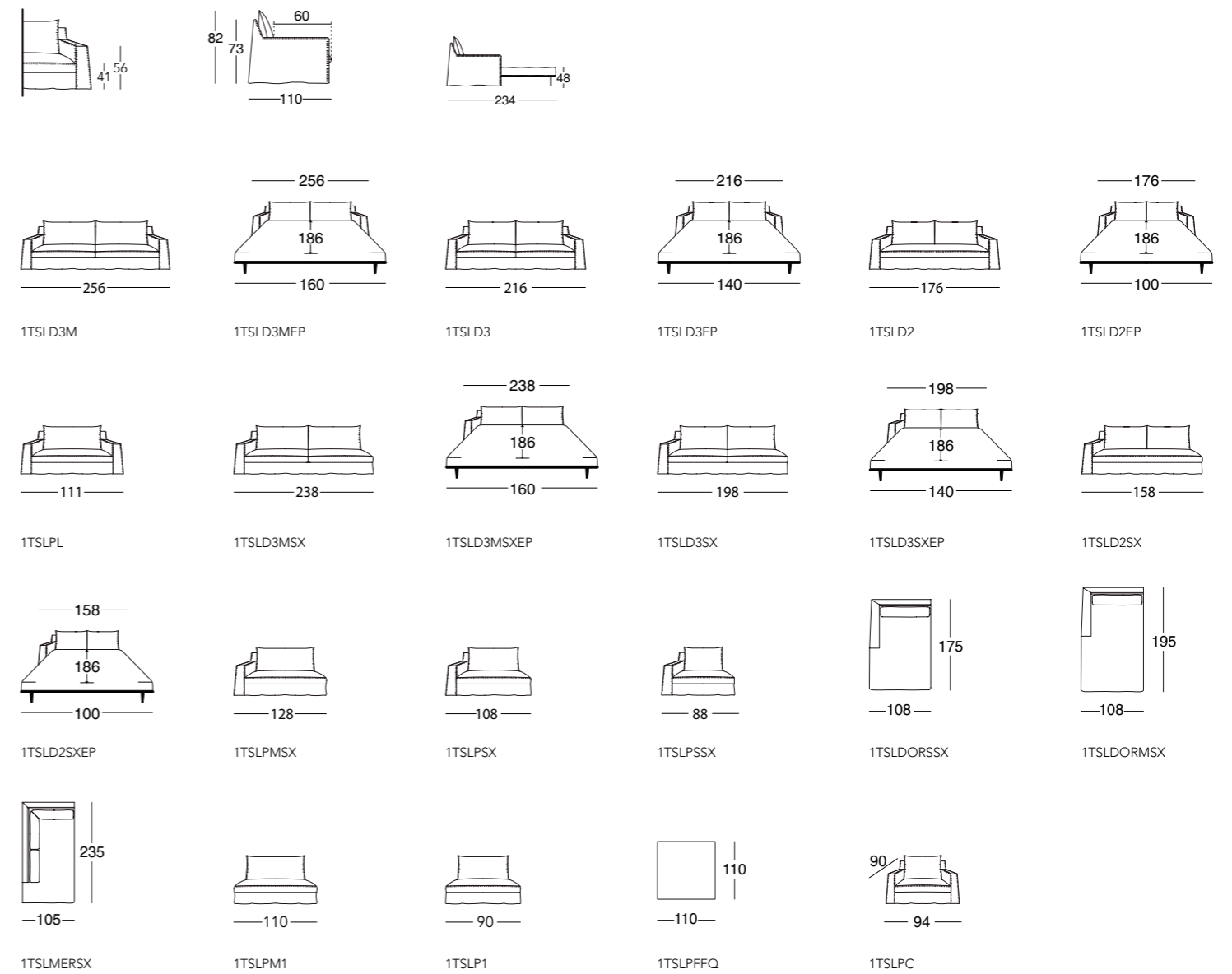

# MIAMI

Pelle | leather | cuir | Leder



## COMPOSIZIONI/COMPOSITIONS/COMPOSITIONS/KOMPOSITIONEN

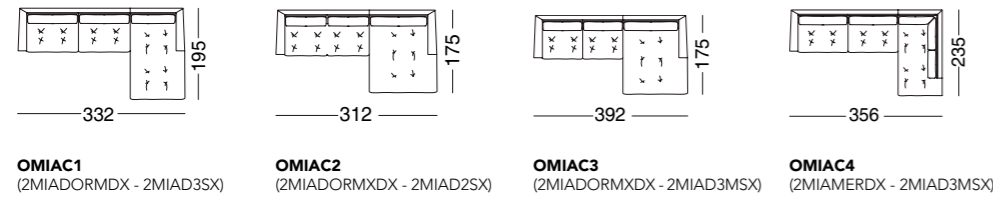

## ELEMENTI/ELEMENTS/ELEMENTS/ELEMENTE

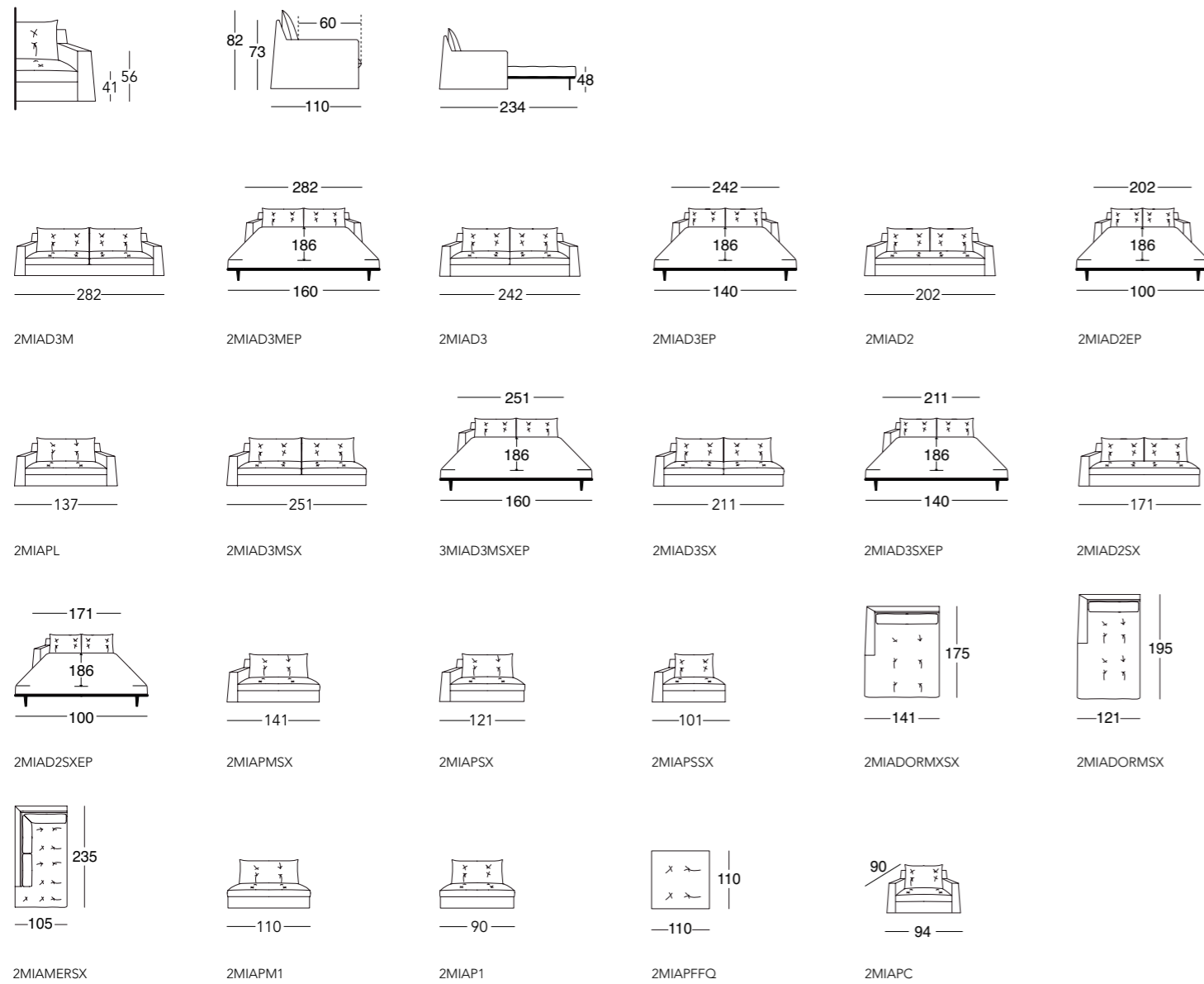

# MIAMI SLIM

Pelle | leather | cuir | Leder



## COMPOSIZIONI/COMPOSITIONS/COMPOSITIONS/KOMPOSITIONEN

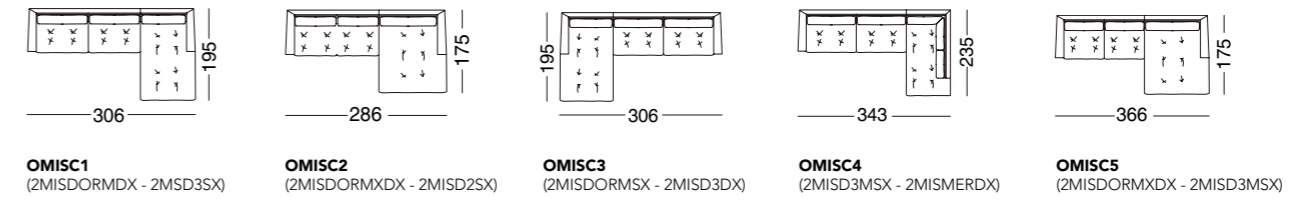

## ELEMENTI/ELEMENTS/ELEMENTS/ELEMENTE

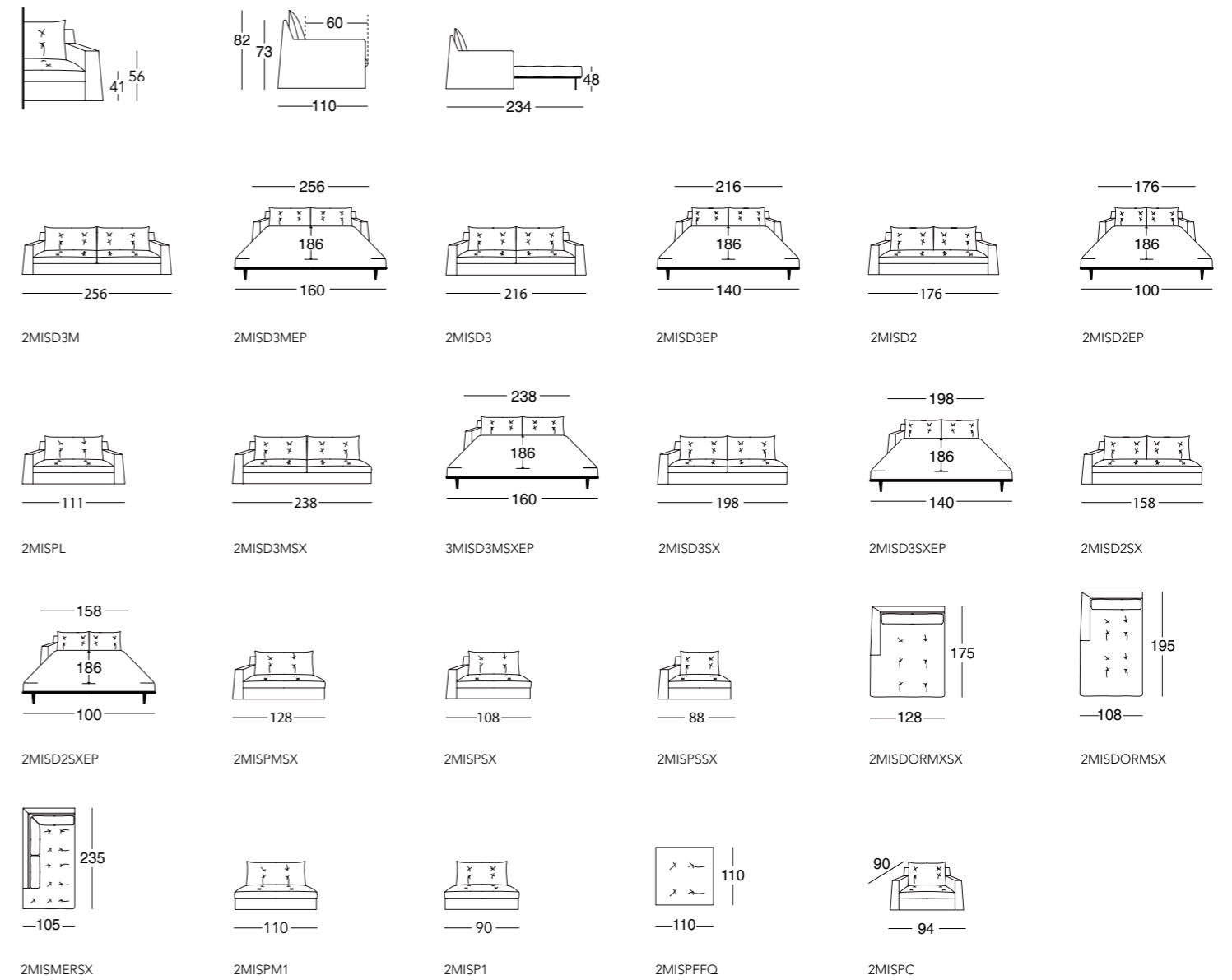



# MIAMI 2

Tessuto | fabric | tissu | Stoff



## COMPOSIZIONI/COMPOSITIONS/COMPOSITIONS/KOMPOSITIONEN

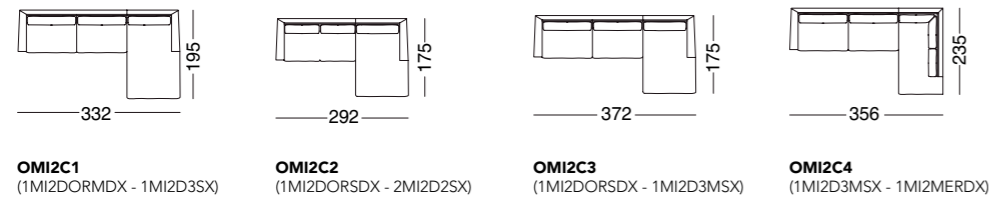

## ELEMENTI/ELEMENTS/ELEMENTS/ELEMENTE

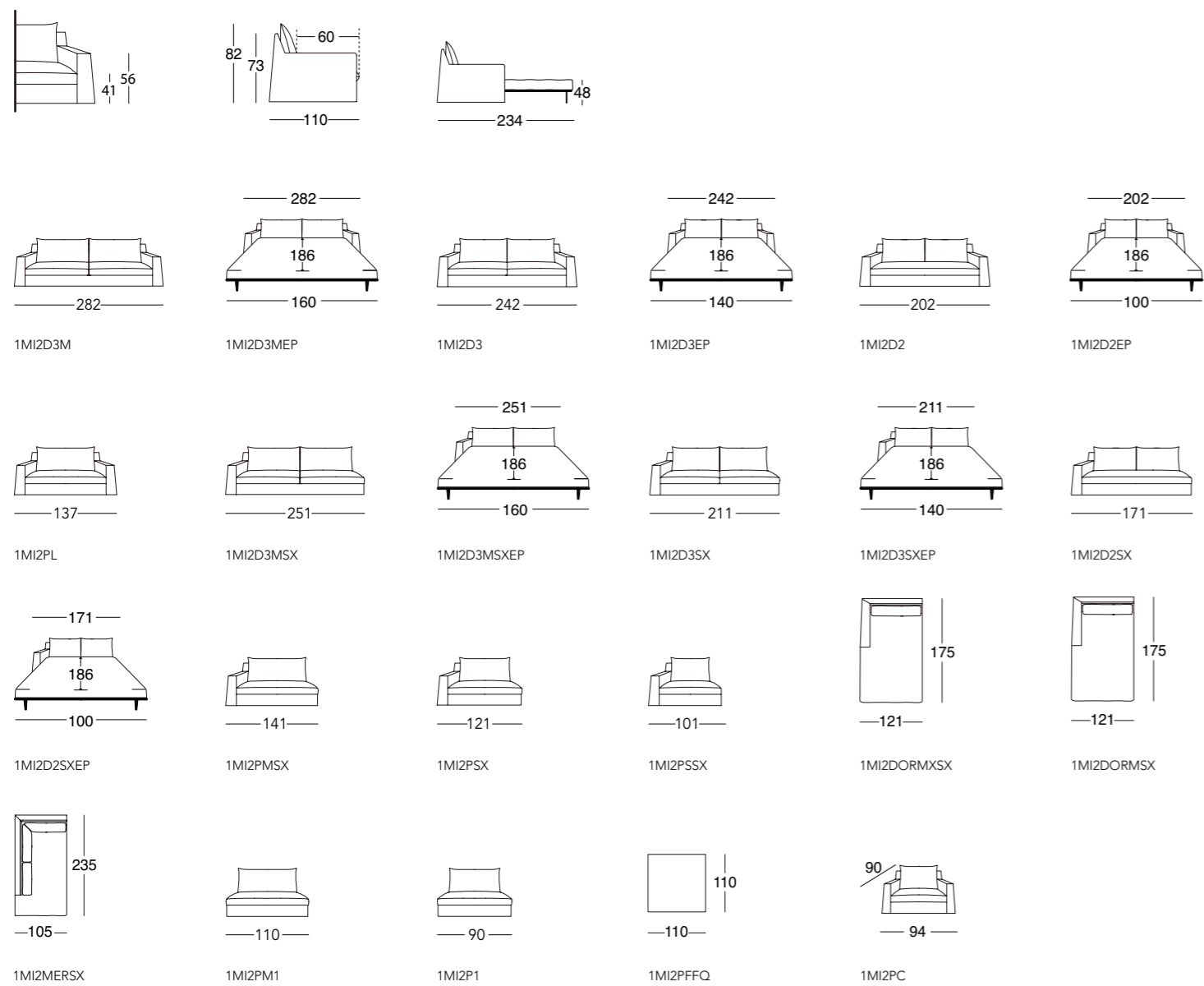

# MIAMI SLIM 2

Tessuto | fabric | tissu | Stoff

## COMPOSIZIONI/COMPOSITIONS/COMPOSITIONS/KOMPOSITIONEN

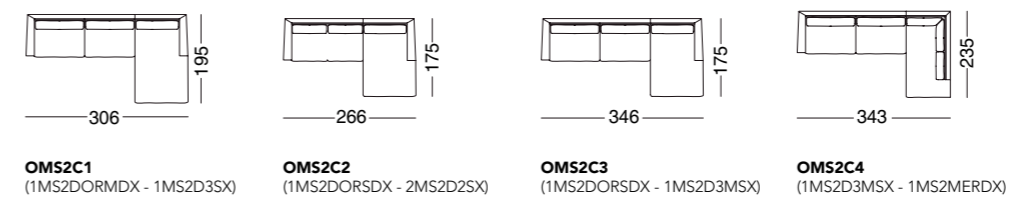

## ELEMENTI/ELEMENTS/ELEMENTS/ELEMENTE

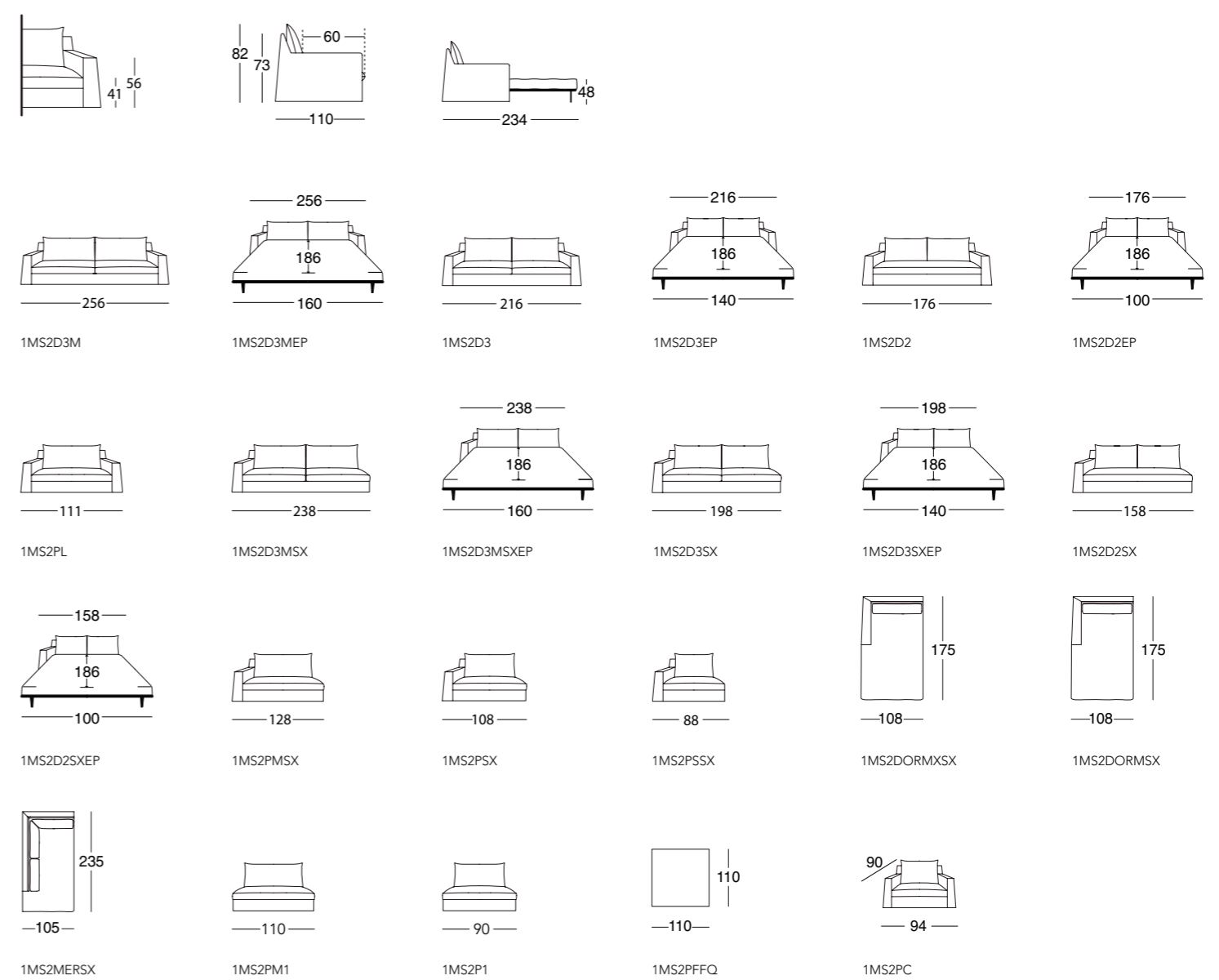

# ROUTE 66

Pelle | leather | cuir | Leder



## COMPOSIZIONI/COMPOSITIONS/COMPOSITIONS/KOMPOSITIONEN

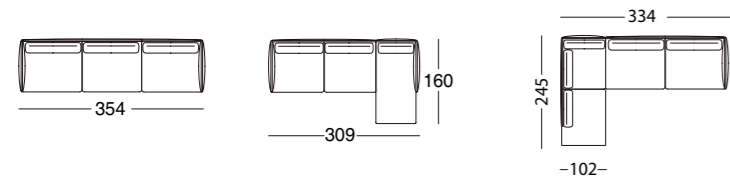

**ORUTC1** (2RUTD3SX - 2RUTPLDX)  
**ORUTC2** (2RUTD2MSX - 2RUTCHLDX)  
**ORUTC3** (2RUTMERMSX - 2RUTD3DX)

## ELEMENTI/ELEMENTS/ELEMENTS/ELEMENTE

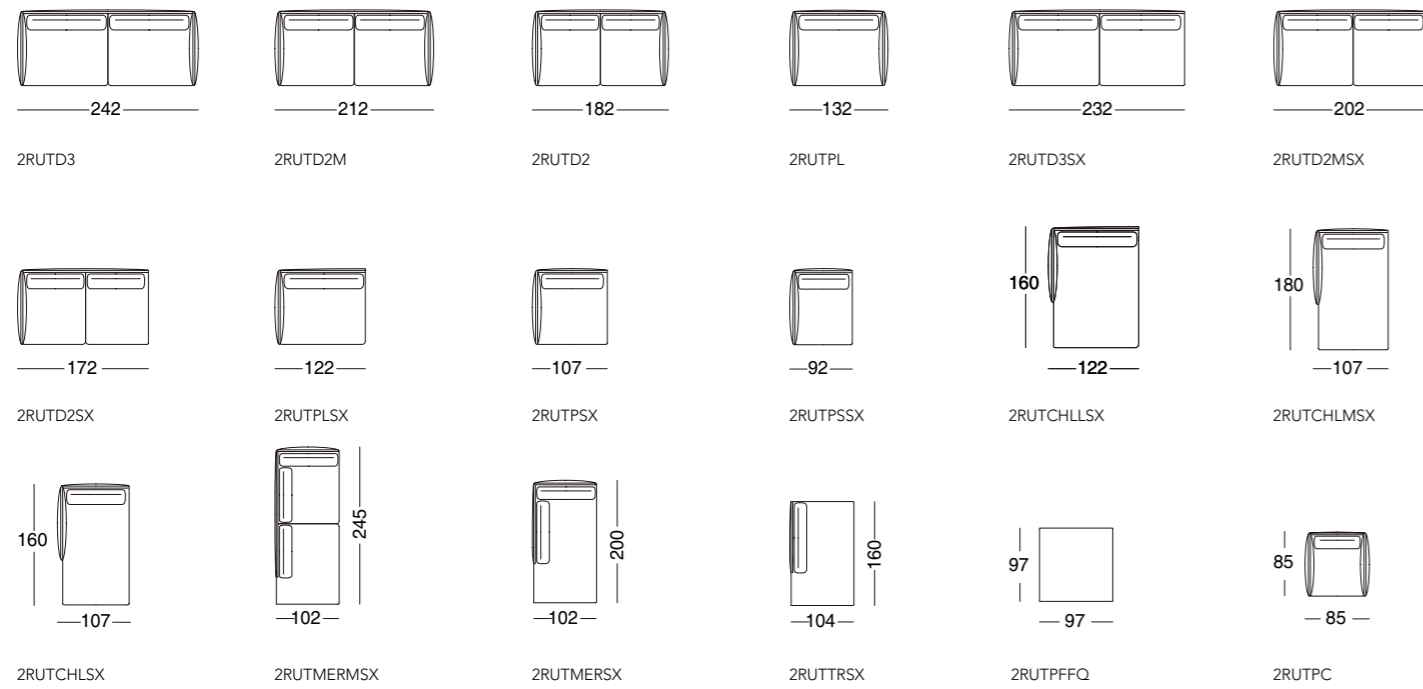
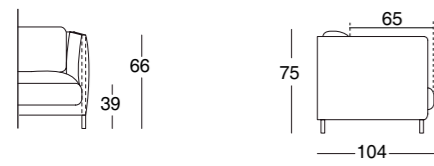

# ROUTE 66

Tessuto | fabric | tissu | Stoff



## COMPOSIZIONI/COMPOSITIONS/COMPOSITIONS/KOMPOSITIONEN

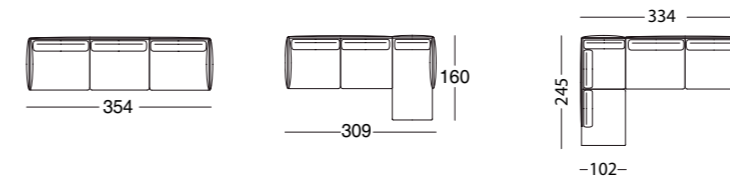

**OR66C1** (1R66D3SX - 1R66PLDX)  
**OR66C2** (1R66D2MSX - 1R66CHLDX)  
**OR66C3** (1R66MERMSX - 1R66D3DX)

## ELEMENTI/ELEMENTS/ELEMENTS/ELEMENTE

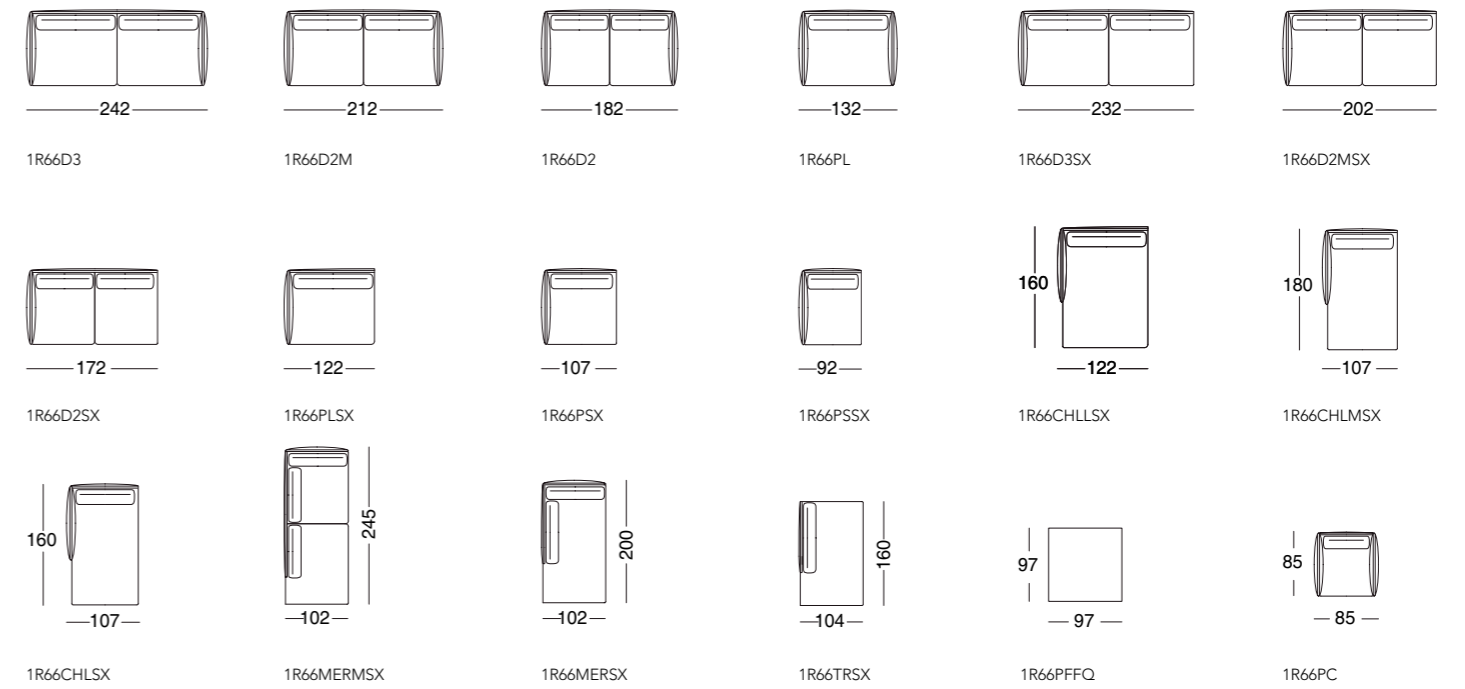

# BRIDGE

Pelle | leather | cuir | Leder



COMPOSIZIONI/COMPOSITIONS/COMPOSITIONS/KOMPOSITIONEN

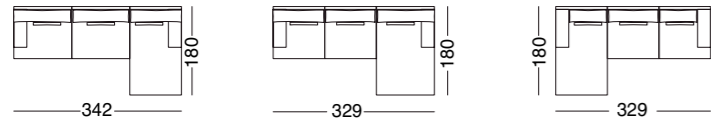

**OBRIC1**  
(2BRIDORMDX - 2BRID3SX)  
**OBRIC2**  
(2BRIDORMDX - 2BRID2MSX)  
**OBRIC3**  
(2BRIDORMSX - 2BRID2MDX)

ELEMENTI/ELEMENTS/ELEMENTS/ELEMENTE

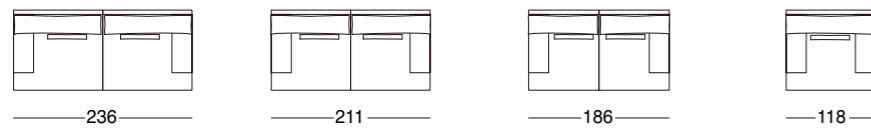
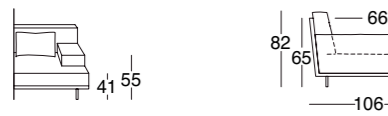

2BRID3      2BRID2M      2BRID2      2BRIP

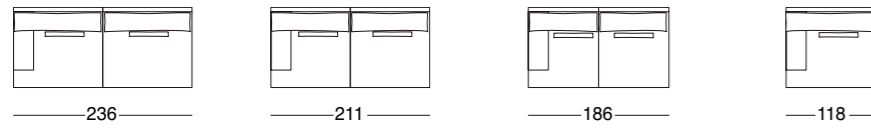

2BRID3SX      2BRID2MSX      2BRID2SX      2BRIPSX

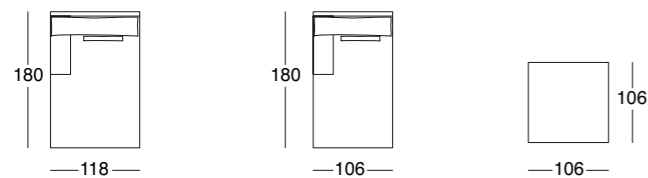

2BRIDORMSX      2BRIDORMSX      2BRIPFFQ

# BRIDGE

Tessuto | fabric | tissu | Stoff



COMPOSIZIONI/COMPOSITIONS/COMPOSITIONS/KOMPOSITIONEN

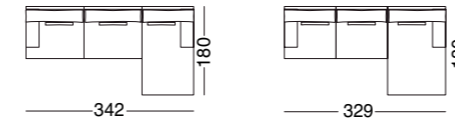

**OBRDC1**  
(1BRDDORMDX - 1BRDD3SX)  
**OBRDC2**  
(1BRDDORMDX - 1BRDD2MSX)

ELEMENTI/ELEMENTS/ELEMENTS/ELEMENTE

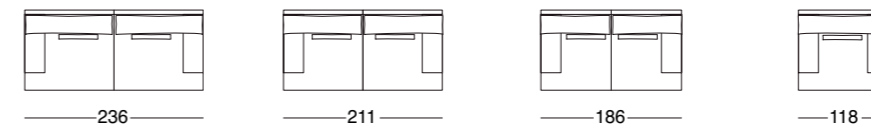

1BRDD3      1BRDD2M      1BRDD2      1BRDP

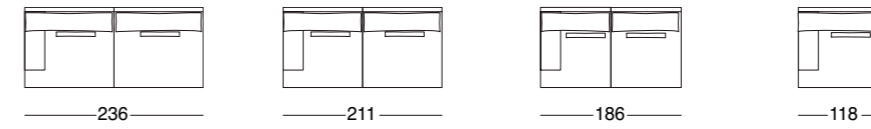

1BRDD3SX      1BRDD2MSX      1BRDD2SX      1BRDPSX

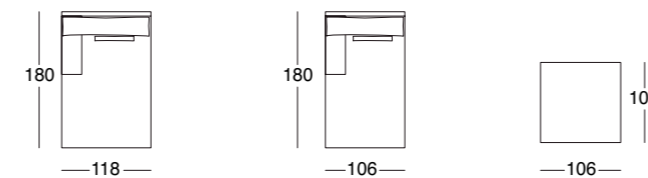

1BRDDORMSX      1BRDDORMSX      1BRDPPFQ



descrizioni tecniche  
*technical descriptions*

**alberta.**

## SIMON

**Struttura portante:** multistrato, massello di legno.

**Imbottiture:** Schienale in piuma d'oca e fibra di poliestere. Seduta in poliuretano espanso (densità 35 Kg/mc), piuma d'oca e fibra di poliestere.

**Versione letto:** nella versione letto gli elementi sono dotati di rete elettrosaldata e materasso in poliuretano espanso ad alta densità.

**Molleggio:** cinghie elastiche.

**Piedino:** in ABS.

**Main structure:** solid wood.

**Upholstery:** Back cushion in goose feathers and polyester fiber. Seat cushion in polyurethane foam (density 35 kg/mc), goose feathers and polyester fiber.

**Sofa-bed version:** in the sofa-bed version the elements are equipped with electrically- welded spring and high-density polyurethane foam mattress.

**Suspensions:** elastic belts.

**Feet:** in ABS.

**Structure:** Multiplis et bois massif.

**Rembourrage:** Dossier en plume d'oie et fibre de polyester. Assise en mousse de polyuréthane (densité 35 kg/mc), plume d'oie et fibre de polyester.

**Version lit:** dans la version lit les éléments sont dotés de sommier électrosoudé et matelas en mousse de polyuréthane haute densité.

**Suspension:** sangles élastiques.

**Feet:** en ABS.

**Struktur:** vielschichtiges Massivholz.

**Polsterung:** Rückenlehne aus Daunen und Polyesterfaser. Sitz aus Polyurethanschaum (Dichte 35 kg /m³), Gänsedaunen und Polyesterfaser.

**Schlafsofa-Version:** in der Bett Version sind die Elemente mit verschweißtem Lattenrost und Matratze aus Polyurethanschaum hoher Dichte versehen

**Federung:** elastische Gurte.

**Füße:** ABS.



## HAMILTON

**Struttura portante:** multistrato, massello di legno.

**Imbottiture:** Schienale in piuma d'oca e fibra di poliestere. Seduta in poliuretano espanso (densità 35 Kg/mc), piuma d'oca e fibra di poliestere.

**Versione letto:** nella versione letto gli elementi sono dotati di rete elettrosaldata e materasso in poliuretano espanso ad alta densità.

**Molleggio:** cinghie elastiche.

**Piedino:** in ABS.

**Main structure:** solid wood.

**Upholstery:** Back cushion in goose feathers and polyester fiber. Seat cushion in polyurethane foam (density 35 kg/mc), goose feathers and polyester fiber.

**Sofa-bed version:** in the sofa-bed version the elements are equipped with electrically- welded spring and high-density polyurethane foam mattress.

**Suspensions:** elastic belts.

**Feet:** in ABS.

**Structure:** Multiplis et bois massif.

**Rembourrage:** Dossier en plume d'oie et fibre de polyester. Assise en mousse de polyuréthane (densité 35 kg/ mc), plume d'oie et fibre de polyester.

**Version lit:** dans la version lit les éléments sont dotés de sommier électrosoudé et matelas en mousse de polyuréthane haute densité.

**Suspension:** sangles élastiques.

**Feet:** en ABS.

**Struktur:** vielschichtiges Massivholz.

**Polsterung:** Rückenlehne aus Daunen und Polyesterfaser. Sitz aus Polyurethanschaum (Dichte 35 kg /m³), Gänsedaunen und Polyesterfaser.

**Schlafsofa-Version:** in der Bett Version sind die Elemente mit verschweißtem Lattenrost und Matratze aus Polyurethanschaum hoher Dichte versehen.

**Federung:** elastische Gurte.

**Füße:** ABS.



## ELLE

**Struttura portante:** multistrato, massello di legno.

**Imbottiture:** Schienale in poliuretano espanso (densità 21 Kg/mc). Seduta in poliuretano espanso (densità 35 Kg/mc). Scocca in poliuretano espanso (densità 21 Kg/mc).

**Bracciolo:** in metallo cromato con copribraccioli in pelle o tessuto (a seconda del rivestimento della poltrona).

**Molleggio:** cinghie elastiche.

**Versione fissa:** piede in metallo cromato.

**Versione girevole:** basamento in metallo forma conica, finitura cromata.

**Main Structure:** solid wood.

**Upholstery:** Back cushion in polyurethane foam (density 21 kg/mc). Seat cushion in polyurethane foam (density 35 kg/mc). Chassis in polyurethane foam (density 21 kg/mc).

**Arm:** chromium-plated metal armrest with covers in leather or fabric (according to the armchair cover).

**Suspensions:** elastic belts.

**Fix version:** chromium-plated metal feet.

**Swivel version:** metal base - conical shape, chromium finishing.

**Structure:** Multiplis et bois massif.

**Rembourrage:** Dossier en mousse de polyuréthane (densité 21 kg/mc). Assises en mousse de polyuréthane (densité 35 kg/mc). Chassis en mousse de polyuréthane (densité 21 kg/mc).

**Accoudoir:** en métal chromé avec couvre-accoudoirs en cuir ou tissu (selon la housse du fauteuil).

**Suspension:** sangles élastiques.

**Version fixe:** pied en métal chromé.

**Version tournante:** piétement en métal avec forme à cône, finition chromé.

**Struktur:** vielschichtiges Massivholz.

**Polsterung:** Rückenlehne aus Polyurethanschaum (Dichte 21 kg/m³). Sitz aus Polyurethanschaum (Dichte 35 kg/m³). Struktur aus Polyurethanschaum (Dichte 21 kg /m³).

**Armlehnen:** verchromtes Metall mit Abdeckungen aus Stoff oder Leder (je nach Sesselbezug).

**Federung:** elastische Gurte.

**Fest-Version:** Fuß in verchromtem Metall.

**Dreh-Version:** konisch geformte Metallbasis, verchromte Feinverarbeitung.

## SANTORINI

**Struttura portante:** massello di legno e suoi derivati.

**Imbottiture:** Cuscino di schienale in piuma d'oca, con inserto in poliuretano espanso (densità 25 Kg/mc), rivestito in tela di cotone. Cuscino di seduta in poliuretano espanso (densità 40 Kg/mc), imbottitura in piuma d'oca (50%) e fibra di poliestere cava (50%) rivestito in tela di cotone/poliestere. Scocca in poliuretano espanso a densità differenziata con rivestimento in fibra termolegata 300 gr accoppiato a vellutino e resinato 200 gr.

**Versione letto:** nella versione letto gli elementi sono dotati di rete elettrosaldata e materasso in poliuretano espanso ad alta densità.

**Molleggio:** molle in acciaio tipo "nosag".

**Piedino:** in ABS.

**Main Structure:** solid wood and wood derivatives.

**Upholstery:** Back cushion in polyurethane foam (density 25 kg/mc) with upper part in goose feathers covered with cotton fabric. Seat cushion in polyurethane foam (density 40 kg/mc) with goose feathers (50%) and polyester fiber (50%) padding covered with cotton /polyester fabric. Chassis in polyurethane foam with different densities covered with thermo-bonded fiber 300 grams, elastic velvet and resinated 200 grams.

**Sofa-bed version:** in the sofa-bed version the elements are equipped with electrically- welded spring and high-density polyurethane foam mattress.

**Suspensions:** steel springs ("nosag").

**Feet:** in ABS.

**Structure:** bois massif et dérivés.

**Rembourrage:** Dossier en plume d'oie avec âme en mousse de polyuréthane (densité 25 kg/ mc), sous housse de coton. Assise en mousse de polyuréthane (densité 40 kg/mc), et plume d'oie (50%) et fibre de polyester (50%) sous housse de coton/polyester.

Chassis en mousse de polyuréthane en plusieurs densités recouvert avec fibre thermolié 300 gr et du velours 200 gr.

**Version lit:** dans la version lit les éléments sont dotés de sommier électrosoudé et matelas en mousse de polyuréthane haute densité.

**Suspension:** ressorts en acier ("nosag").

**Pied:** en ABS.

**Struktur:** Massivholz und seine Derivate.

**Polsterung:** Rückenkissen aus Daunen mit Einsatz aus Polyurethanschaum (Dichte 25 kg/ m³), mit einem Baumwolltuch abgedeckt. Sitzkissen aus Polyurethanschaum (Dichte 40 kg/ m³), Füllung mit Gänsedaunen (50%) und Polyester- Hohlfasern (50%) mit Baumwolle /Polyester Bezug abgedeckt. Struktur aus Polyurethanschaum mit unterschiedlicher Dichte und Bezug in verbundwärmeregelnder Faser 300 Gramm mit gekoppeltem Samt und 200 Gramm Harz.

**Schlafsofa-Version:** in der Bett Version sind die Elemente mit verschweißtem Lattenrost und Matratze aus Polyurethanschaum hoher Dichte versehen.

**Federsystem:** Stahlfedern Typ "Nosag".

**Füße:** ABS.



## BELLAVITA - dormeuse

**Struttura portante:** multistrato, massello di legno.

**Imbottiture:** Schienale in poliuretano espanso a densità differenziata (40-30 Kg/mc). Poggiatesta in piuma d'oca. Seduta in poliuretano espanso a densità differenziata (35-30-30 Kg/mc).

**Molleggio:** cinghie elastiche.

**Piedino:** in ABS.

**Main Structure:** solid wood.

**Upholstery:** Back cushion in polyurethane foam with different densities (40-30 Kg/mc).

Headrest in goose feathers. Seat cushion in polyurethane foam with different densities (35-30-30 Kg/mc).

**Suspensions:** elastic belts.

**Feet:** in ABS.

**Structure:** Multiplis et bois massif.

**Rembourrage:** Dossier en mousse de polyuréthane avec plusieurs densités (40-30 kg/mc).

Appui-tête en plume d'oie. Assise en mousse de polyuréthane avec plusieurs densités (35-30-30 kg/mc).

**Suspension:** sangles élastiques.

**Pied:** en ABS.

**Struktur:** vielschichtiges Massivholz.

**Polsterung:** Rückenlehne aus Polyurethanschaum mit unterschiedlicher Dichte (40-30 kg/m). Kopfstütze aus Gänsedaunen. Sitz aus Polyurethanschaum mit unterschiedlicher Dichte (35-30-30 kg/m³).

**Federung:** elastische Gurte.

**Füße:** ABS



## THEO/THEO SLIM/THEO 2/THEO SLIM 2

**Struttura portante:** in massello di legno e suoi derivati.

**Imbottiture:** seduta in poliuretano espanso (densità 35 Kg/mc) piuma d'oca e fibra di poliestere.

Schienale in poliuretano espanso (densità 23 Kg/mc) piuma d'oca e fibra di poliestere.

**Versione letto:** nella versione con letto sono dotati di rete elettrosaldata e materasso in poliuretano espanso ad alta densità.

**Molleggio:** cinghie elastiche.

**Piedino:** in ABS.

**Main structure:** in solid wood and wood derivatives.

**Upholstery:** seat cushion in polyurethane foam (density 35 Kg/mc) goose feathers and polyester fiber.

Back cushion in polyurethane foam (density 23 Kg/mc) goose feathers and polyester fiber.

**Sofa-bed version:** in the sofa-bed version the models are equipped with electrically-welded spring and high density polyurethane foam mattress.

**Suspensions:** elastic belts.

**Feet:** in ABS.

**Structure:** bois massif et derives.

**Rembourrage:** assise en mousse de polyuréthane (densité 35 kg/mc) plume d'oie et fibre de polyester. Dossier en mousse de polyuréthane (densité 23 kg/mc), plume d'oie et fibre de polyester.

**Version lit:** dans la version lit les éléments sont dotés de sommier électrosoudé et matelas en mousse de polyuréthane haute densité.

**Suspension:** sangles élastiques.

**Pied:** en ABS.

**Struktur:** Massivholz und seine Derivate.

**Polsterung:** Sitz aus Polyurethanschaum (Dichte 35 kg/ m³) Gänsedaunen und Polyesterfaser. Rückenlehne aus Polyurethanschaum (Dichte 23 kg/ m³) Gänsedaunen und Polyesterfaser.

**Schlafsofa-Version:** mit elektro-geschweißtem Lattenrost und mit Matratze aus Polyurethanschaum hoher Dichte versehen.

**Federung:** elastische Gurte.

**Füße:** ABS.



## MIAMI/MIAMI SLIM/MIAMI 2/MIAMI SLIM 2

**Struttura portante:** in massello di legno e suoi derivati.

**Imbottiture:** seduta in poliuretano espanso (densità 35 Kg/mc) e fibra termolegata.

Schienale in poliuretano espanso (densità 23 Kg/mc) e fibra termolegata.

**Versione letto:** nella versione con letto sono dotati di rete elettrosaldata e materasso in poliuretano espanso ad alta densità.

**Molleggio:** cinghie elastiche.

**Piedino:** in ABS.

**Main structure:** in solid wood and wood derivatives.

**Upholstery:** seat cushion in polyurethane foam (density 35 Kg./mc) and thermo-bonded fiber.

Back cushion in polyurethane foam (density 23 Kg/mc) and thermo-bonded fiber.

**Sofa-bed version:** in the sofa-bed version the models are equipped with electrically-welded spring and high density polyurethane foam mattress.

**Suspensions:** elastic belts.

**Feet:** in ABS.

**Structure:** bois massif et dérivés.

**Rembourrage:** assise en mousse de polyuréthane (densité 35 kg/mc) et fibre thermolié. Dossier en mousse de polyuréthane (densité 23 kg/mc), et fibre thermolié.

**Version lit:** dans la version lit les éléments sont dotés de sommier électrosoudé et matelas en mousse de polyuréthane haute densité.

**Suspension:** sangles élastiques.

**Pied:** en ABS.

**Struktur:** Massivholz und seine Derivate.

**Polsterung:** Sitz aus Polyurethanschaum (Dichte 35 kg/m³) und verbundwärmeregelnde Fasern. Rückenlehne aus Polyurethanschaum (Dichte 23 kg/m³) und verbundwärmeregelnde Fasern.

**Schlafsofa-Version:** mit elektro-geschweißtem Lattenrost und mit Matratze aus Polyurethanschaum hoher Dichte versehen.

**Federung:** elastische Gurte.

**Füße:** en ABS.

## ROUTE 66

**Struttura portante:** multistrato, massello di legno.

**Imbottiture:** Schienale in poliuretano espanso (densità 23 Kg/mc) e piuma d'oca. Seduta in poliuretano espanso (densità 40 Kg/mc) e piuma d'oca.

**Molleggio:** cinghie elastiche.

**Piedino:** Tubo metallico h. 10 cm (standard) o staffa h. 14 cm (opzionale). Finitura cromata o vernice grigio opaco.

**Main Structure:** solid wood.

**Upholstery:** Back cushion in polyurethane foam (density 23 kg/mc) and goose feathers. Seat cushion in polyurethane foam (density 40 kg/mc) and goose feathers.

**Suspensions:** elastic belts.

**Feet:** metal tube h. 10 cms (standard) or stirrup h. 14 cms (optional) with chromium or matt grey varnish finishing.

**Structure:** Multiplis et bois massif.

**Rembourrage:** Dossier en mousse de polyuréthane (densité 23 kg/mc). Assise en mousse de polyuréthane (densité 40 kg/mc) et plume d'oie.

**Suspension:** sangles élastiques.

**Pied:** tube en métal h. 10 cms (standard) ou étrier h. 14 cm (optionnel) finition chrome ou verni gris mat.

**Struktur:** vielschichtiges Massivholz.

**Polsterung:** Rückenlehne in Polyurethanschaum (Dichte 23 kg/m³) und Daunen. Sitz aus Polyurethanschaum (Dichte 40 kg /m³) und Gänsedaunen.

**Federung:** elastische Gurte.

**Füße:** Metallrohr h. 10 cm (Standard) oder Bügel h. 14 cm (optional) Chrome oder matt-graue Feinverarbeitung.



Cod. PD10179  
OPTIONAL  
FINISHING

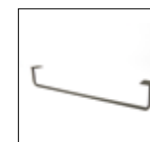

Cod. PD10180  
OPTIONAL  
FINISHING

## BRIDGE

**Struttura portante:** in metallo e multistrato in massello di legno.

**Imbottiture:** seduta in poliuretano espanso a densità differenziata (35/40 Kg/mc) e fibra termolegata. Schienale in poliuretano espanso (densità 21 Kg/mc) e fibra termolegata. Poggiareni in piuma d'oca e fibra di poliestere.

**Molleggio:** cinghie elastiche.

**Piedino:** in metallo verniciato.

**Main structure:** in metal and solid wood.

**Upholstery:** seat cushion in polyurethane foam with different densities (35/40 Kg/mc) and thermo-bonded fiber. Back cushion in polyurethane foam (density 21 Kg/mc) and thermo-bonded fiber. Backrest pillows in goose feathers and polyester fiber.

**Suspensions:** elastic belts.

**Feet:** in varnished metal.

**Structure:** en métal et bois massif.

**Rembourrage:** assise en mousse de polyuréthane en plusieurs densités (35/40 kg/mc) et fibre thermolié. Dossier en mousse de polyuréthane (densité 21 kg/mc), et fibre thermolié. Cale-reins en plume d'oie et fibre de polyester.

**Suspension:** sangles élastiques.

**Pied:** en métal verni.

**Struktur:** in Metall und vielschichtiges Massivholz.

**Polsterung:** Sitz aus Polyurethanschaum mit unterschiedlicher Dichte ( 35/40 Kg / m<sup>3</sup> ) und verbundwärmeregelnde Fasern. Rückenlehne aus Polyurethanschaum (Dichte 21 kg /m<sup>3</sup>) und verbundwärmeregelnde Faser. Nierenkissen aus Daunen und Polyesterfaser.

**Federung:** elastische Gurte.

**Füße:** lackiertes Metall.



## COMPANY PROFILE

Il marchio ALBERTA da trent'anni rappresenta garanzia di qualità nella progettazione e nella produzione di divani e poltrone. L'azienda opera nel trevigiano, nord-est Italia, dal cui sostrato culturale ha attinto sia la tradizione artigiana sia l'attitudine alla creatività ed al design. Nel corso della sua storia ha sviluppato nei diversi stabilimenti linee di imbottiti sempre rispondenti all'evoluzione del gusto nelle due divisioni base che raggruppano le collezioni in tessuto e quelle in pelle. L'esperienza nell'impiego di entrambi i materiali consente ad Alberta di essere altamente propositiva. L'obiettivo dell'azienda è offrire soluzioni originali di ottimo livello estetico, pratico e qualitativo nel rispetto dei principi dell'etica ambientale.

*For thirty years the ALBERTA brand has been recognised as a guarantee of quality in the design and production of sofas and armchairs. The company is headquartered in the Province of Treviso in the north east of Italy and has taken both its tradition of fine craftwork and its passion for creativity and design from this stimulating and active land. In order to meet the needs of ever-changing tastes the company has developed and now manufactures an extensive range of products based on two basic divisions, their textile and leather furniture collections. The experience they have gained working with these materials enables Alberta to be proactive and continually develop new solutions. The company mission is to create original products which combine great looks with practicality and quality while ensuring the utmost respect for the environment.*

*Le marque ALBERTA depuis 30 ans c'est une garantie de qualité dans la projection et fabrication de fauteuils et canapés. L'usine opère dans la province de Treviso, nord-est de l'Italie, et du substrat culturel de cette zone elle a pris soit la tradition artisanale soit la disposition à la créativité et au design. Au cours de l'histoire elle a développé dans les différents usines des lignes des canapés toujours correspondant à l'évolution du goût dans les deux collections en cuir et tissu. L'expérience dans l'utilisations des matériaux a permis à Alberta d'être bien propositive avec ces collections. L'objectif de l'usine est offrir solutions originales de niveau esthétique, pratique et qualitatif excellent dans le respect des principes de l'éthique de l'ambiance.*

*Die Marke ALBERTA steht seit dreißig Jahren als Garantie für Qualität in der Entwicklung und Herstellung von Sofas und Sesseln. Das Unternehmen hat seinen Hauptsitz in der Provinz Treviso, im Nordosten Italiens. Angeregt von dieser Kultur und Landschaft schöpft Alberta sowohl aus der handwerklichen Tradition als auch aus der Begabung und Leidenschaft für Kreativität und Design. Im Laufe seiner Geschichte hat das Unternehmen in seinen verschiedenen Betrieben eine breite Palette von Polstermöbel entwickelt, die den Bedürfnissen der Kunden entgegenkommt. Dabei sind zwei grundlegende Richtungen entstanden: die Stoff- und die Lederkollektion. Die gewonnenen Erfahrungen in der Verwendung mit beiden Materialien ermöglicht Alberta sehr aktiv zu sein und ständig neue Lösungen zu entwickeln. Das Unternehmen hat sich zum Ziel gesetzt, originelle Lösungen mit hohen ästhetischen, praktischen und qualitativen Niveau anzubieten und gleichzeitig umweltfreundlich zu sein.*



La riproduzione totale o parziale è permessa esclusivamente su nostra autorizzazione. Le immagini e i disegni contenuti nel presente catalogo sono puramente rappresentativi di questo prodotto e possono subire variazioni e modifiche anche senza preavviso. Pertanto nella scelta degli articoli per la compilazione dell'ordine, fa fede solamente quanto contenuto nel listino in vigore.

*Reproduction, total or partial, is allowed exclusively under licence from our company. The photographs and drawings in this catalogue are only a representation of products and may be varied and changed without notice. When choosing article for your orders, only the details contained in the price-list in force should be considered.*

*La reproduction totale ou partielle est soumise exclusivement à notre autorisation. Les images et les dessins présents dans ce catalogue sont uniquement des représentations de ce produit et peuvent subir des variations et des modifications même sans préavis. Par conséquent, une fois l'article choisi, lorsque vous remplirez le bon de commande, référez-vous au tarif en vigueur car il est le seul à faire foi.*

*Die Teilweise oder Gesamte Wiedergabe ist Ausschließlich mit unserer Erlaubnis gestattet. Hinweis: Alle in diesem Katalog enthaltenen Abbildungen sind unverbindlich; wir behalten uns das Recht vor, Änderungen oder Verbesserungen ohne Ankündigung durchzuführen. Maßgeblich für die Auswahl der einzelnen zu bestellenden Produkte ist ausschließlich die jeweils gültige Verkaufspreisliste.*

**Set coordination:** Castello Lagravinese Studio

**Photography:** Davide Cerati fotografia

**Styling:** Sissi Valassina

**Graphic assistance:** Cuor Business

**Print:** Grafiche Antiga



SIMON	04
HAMILTON	22
ELLE	32
SANTORINI	36
BELLAVITA	72
THEO	78
THEO SLIM	94
MIAMI	100
MIAMI SLIM	105
MIAMI 2	111
ROUTE 66	114
BRIDGE	134
SHAKE	146
UFO	150

**alberta**<sup>®</sup>  
Made in Italy

**alberta**<sup>®</sup>  
The first name in Italian sofas

Alberta Pacific Furniture S.p.A.  
Via Toniolo, 41  
31028 Vazzola (TV) Italy  
Tel. +39 0438 440440  
Fax +39 0438 441555  
email: [contact@albertasalotti.it](mailto:contact@albertasalotti.it)  
[www.alberta.it](http://www.alberta.it)